

COURTESY & TAIL GATE LAMPS E7DDAD87

COURTESY & TAIL GATE LAMPS (1)

SD929-1

W/O Trip Computer

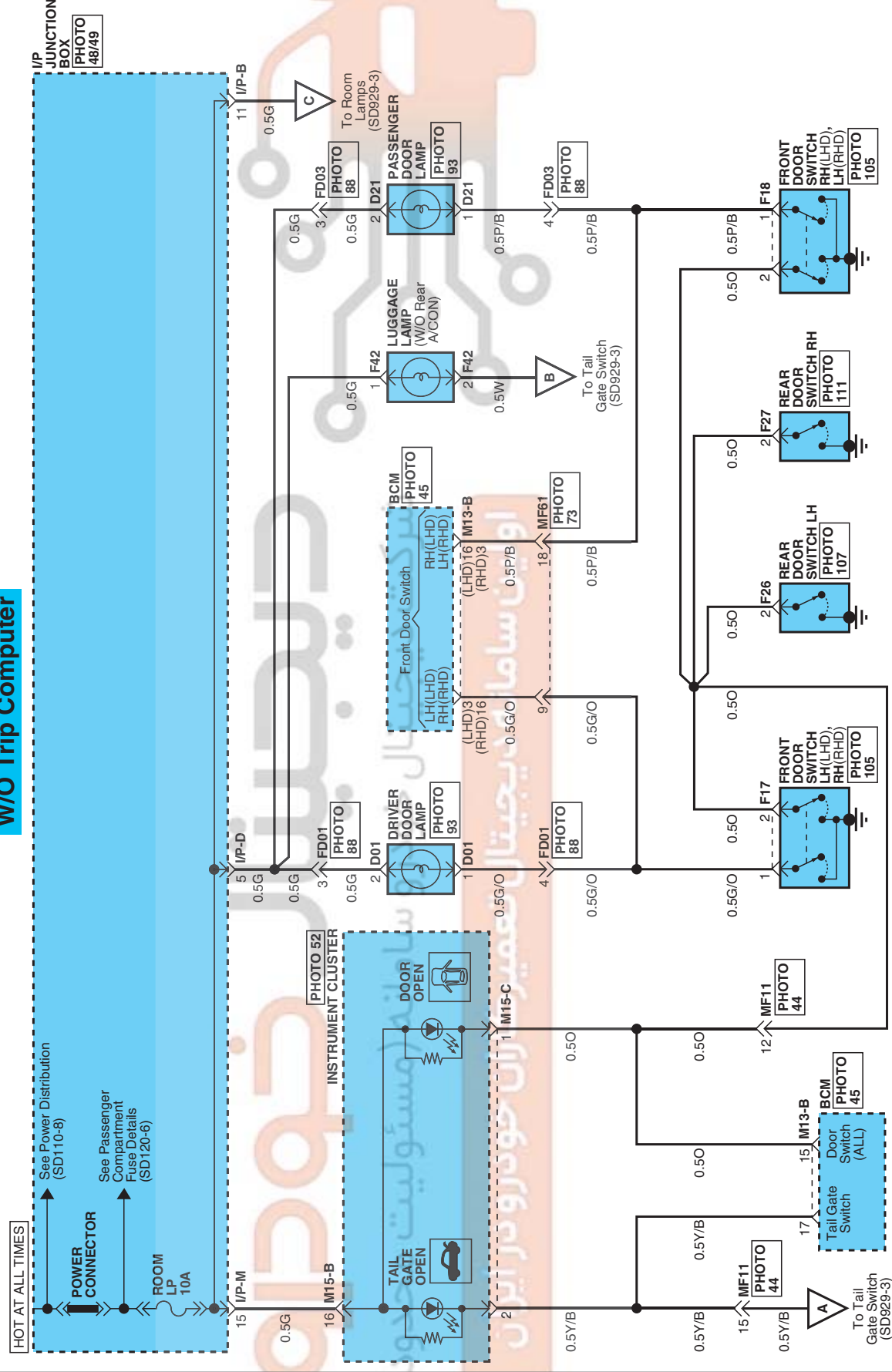

ECMIS07929A

### COURTESY & TAIL GATE LAMPS COURTESY & TAIL GATE LAMPS (2)

SD929-2

With Trip Computer

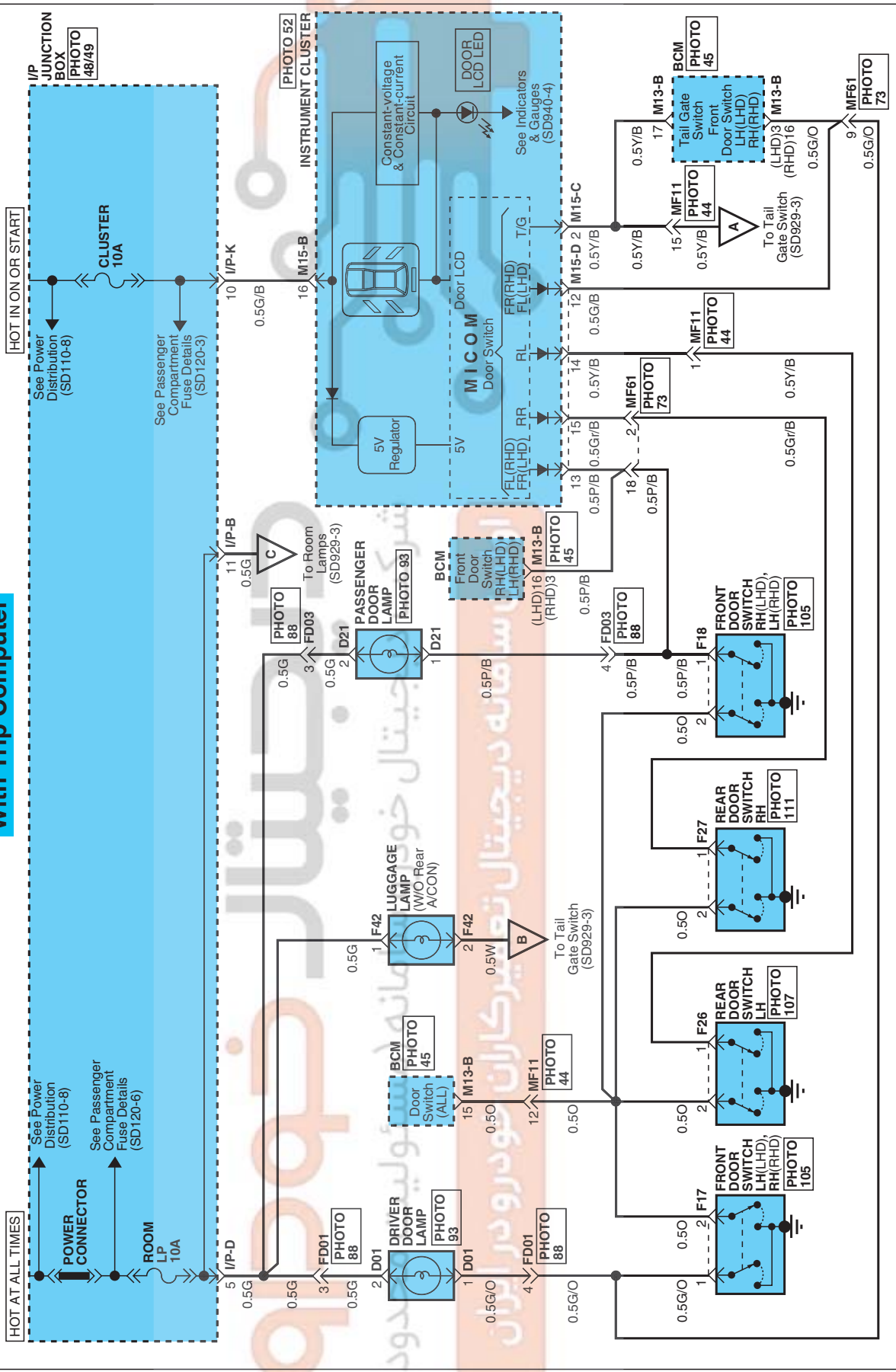

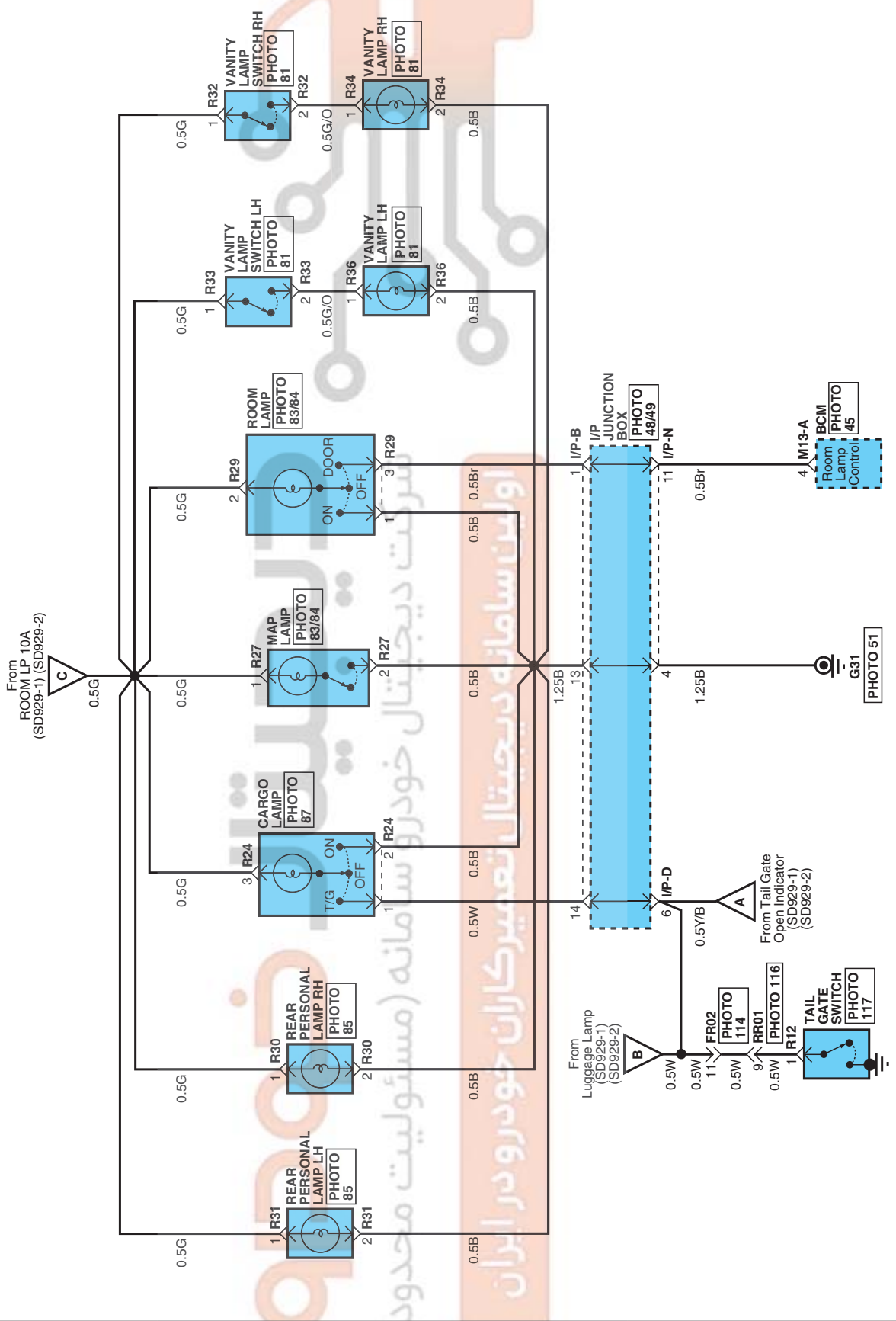

### COURTESY & TAIL GATE LAMPS COURTESY & TAIL GATE LAMPS (3)

SD929-3

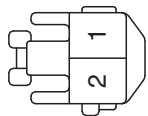
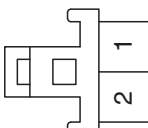
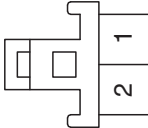
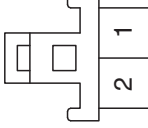
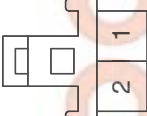
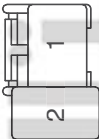
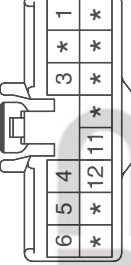
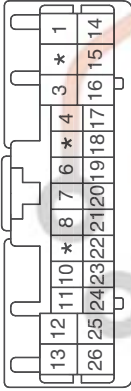
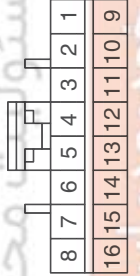
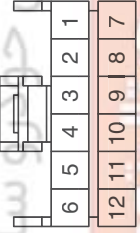

COURTESY & TAIL GATE LAMPS  
COURTESY & TAIL GATE LAMPS (4)

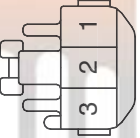
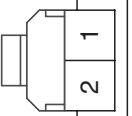
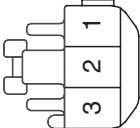
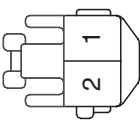
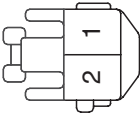
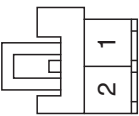
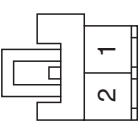
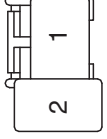
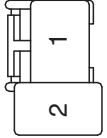
SD929-4			
<p>D01/D21</p>  <p>KET_0901L_02F_W_L</p>	<p>F17</p>  <p>KET_070_02F_W</p>	<p>F18</p>  <p>KET_070_02F_W</p>	<p>F26</p>  <p>KET_070_02F_W</p>
<p>F27</p>  <p>KET_070_02F_W</p>	<p>F42</p>  <p>AMP_PLM2_02F_W</p>	<p>M13-A</p>  <p>KET_0901L_14F_W</p>	<p>M13-B</p>  <p>KET_0407_26F_W</p>
<p>M15-B</p>  <p>AMP_040M2_16F_B</p>	<p>M15-C</p>  <p>AMP_040M1_12F_B</p>	<p>R12</p>  <p>AMP_250DL_01F_B</p>	<p>R24</p>  <p>KET_09011_03F_W</p>
<p>R27</p>  <p>AMP_070_02F_W</p>	<p>R29</p>  <p>KET_0901L_03F_W</p>	<p>R30</p>  <p>KET_0901L_02F_W_L</p>	<p>R31</p>  <p>KET_09011_03F_W</p>
<p>R32</p>  <p>KUM_CDR_02F_W</p>	<p>R33</p>  <p>KUM_CDR_02F_W</p>	<p>R34</p>  <p>AMP_PLM2_02F_B</p>	<p>R36</p>  <p>AMP_PLM2_02F_B</p>