

Circuit diagram

Charging system

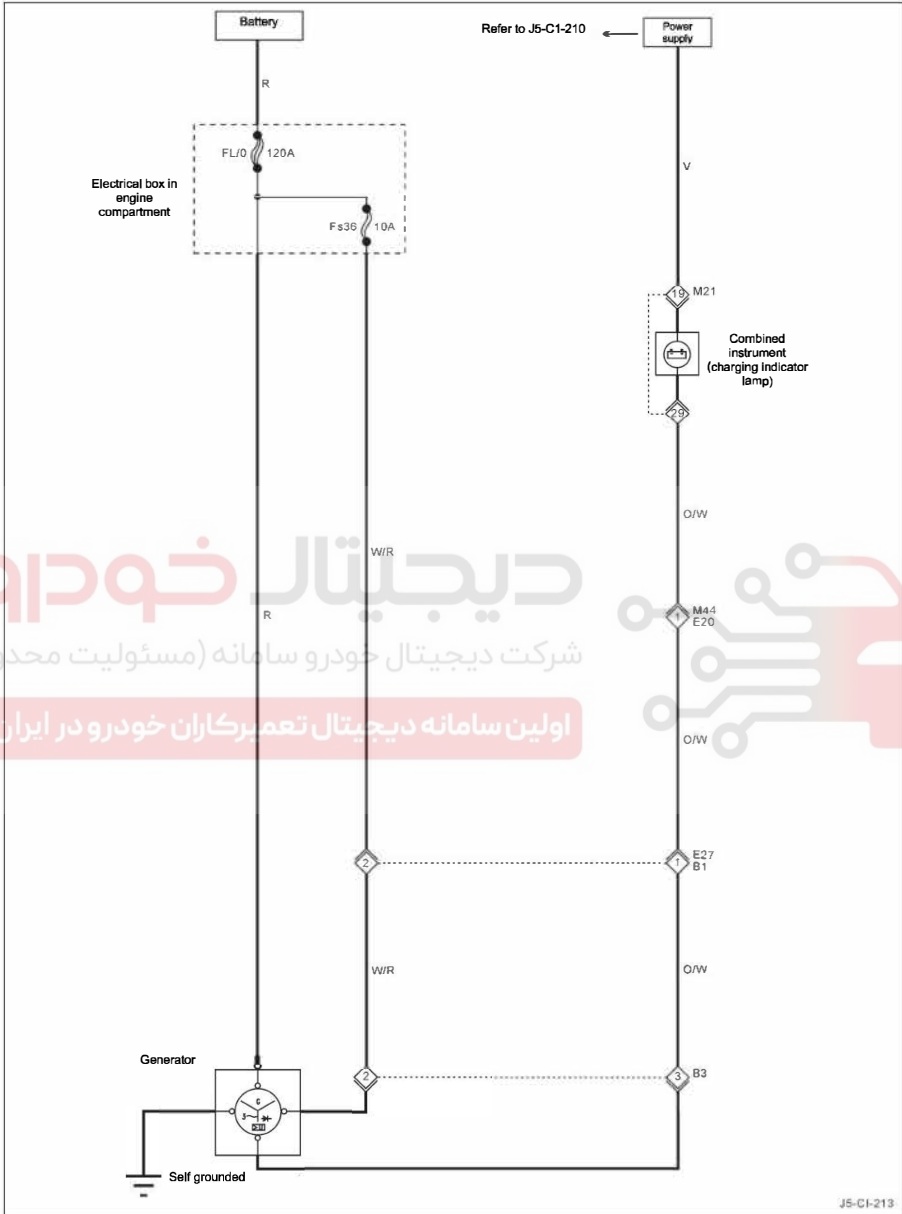

دیجیتال خودرو
شرکت دیجیتال خودرو سامانه (مسئولیت محدود)
اولین سامانه دیجیتال تعمیرکاران خودرو در ایران

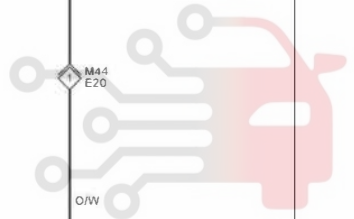

◇: harness plug

No.	No.	Description of harness plug
B1	E27	Power harness – engine harness (below the battery in the engine compartment)
E20	M44	Engine harness – main harness (below and on the left of dashboard)

□: switch and electrical device

No.	Description	Position
B3	To generator	Power harness
M21	To combined instrument	Main harness
M41	To interior electrical box (I/P-K)	Main harness

دیجیتال خودرو

شرکت دیجیتال خودرو سامانه (مسئولیت محدود)

اولین سامانه دیجیتال تعمیرکاران خودرو در ایران



Circuit diagram

Diagnosis interface

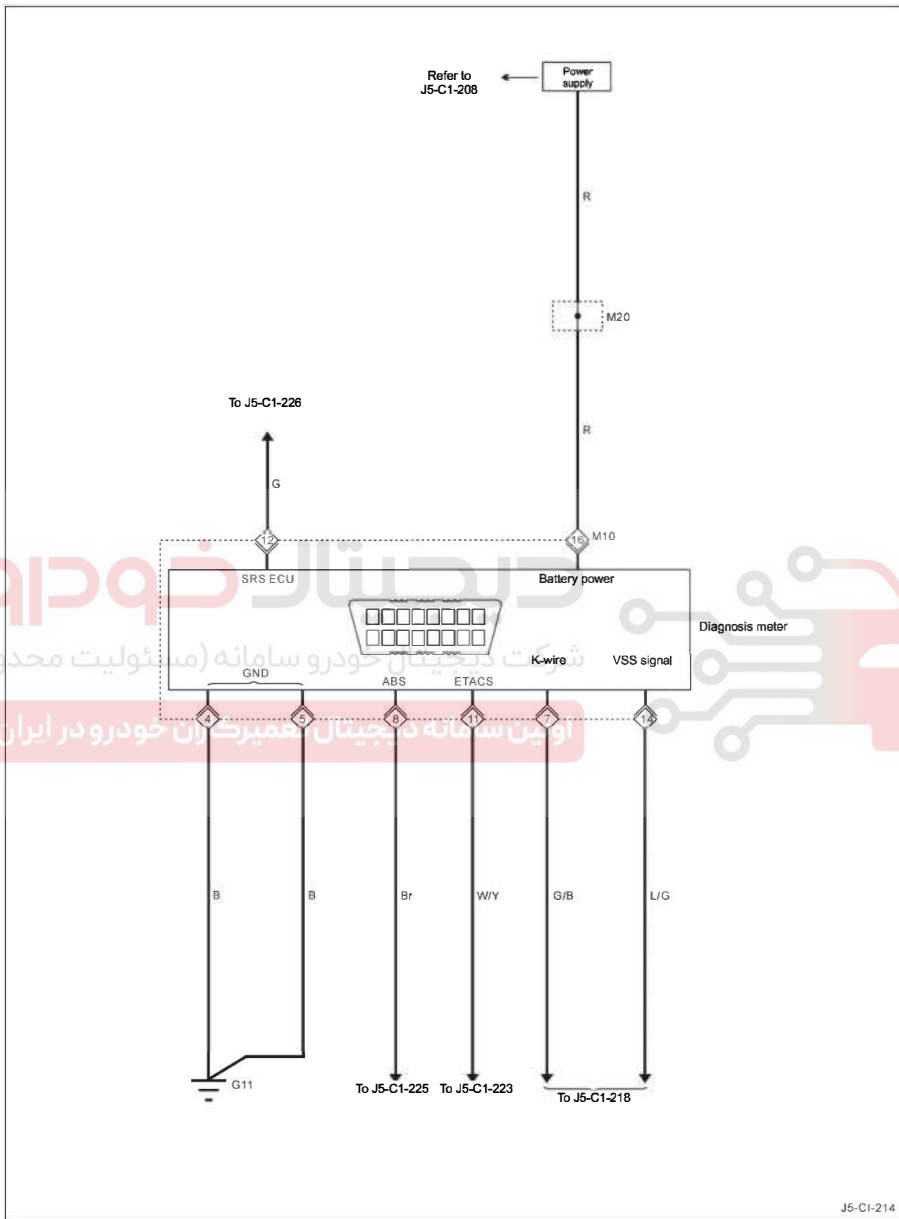

J5-C1-214

Circuit diagram

□: switch and electrical device

No.	Description	Position
E21	To interior electrical box (I/P-C)	Engine harness
M10	To diagnosis interface	Main harness
M20	To short-circuiter	Main harness
M38	To interior electrical box (I/P-J)	Main harness

دیجیتال خودرو

شرکت دیجیتال خودرو سامانه (مسئولیت محدود)

اولین سامانه دیجیتال تعمیرکاران خودرو در ایران



Circuit diagram

Electronic fuel injection system

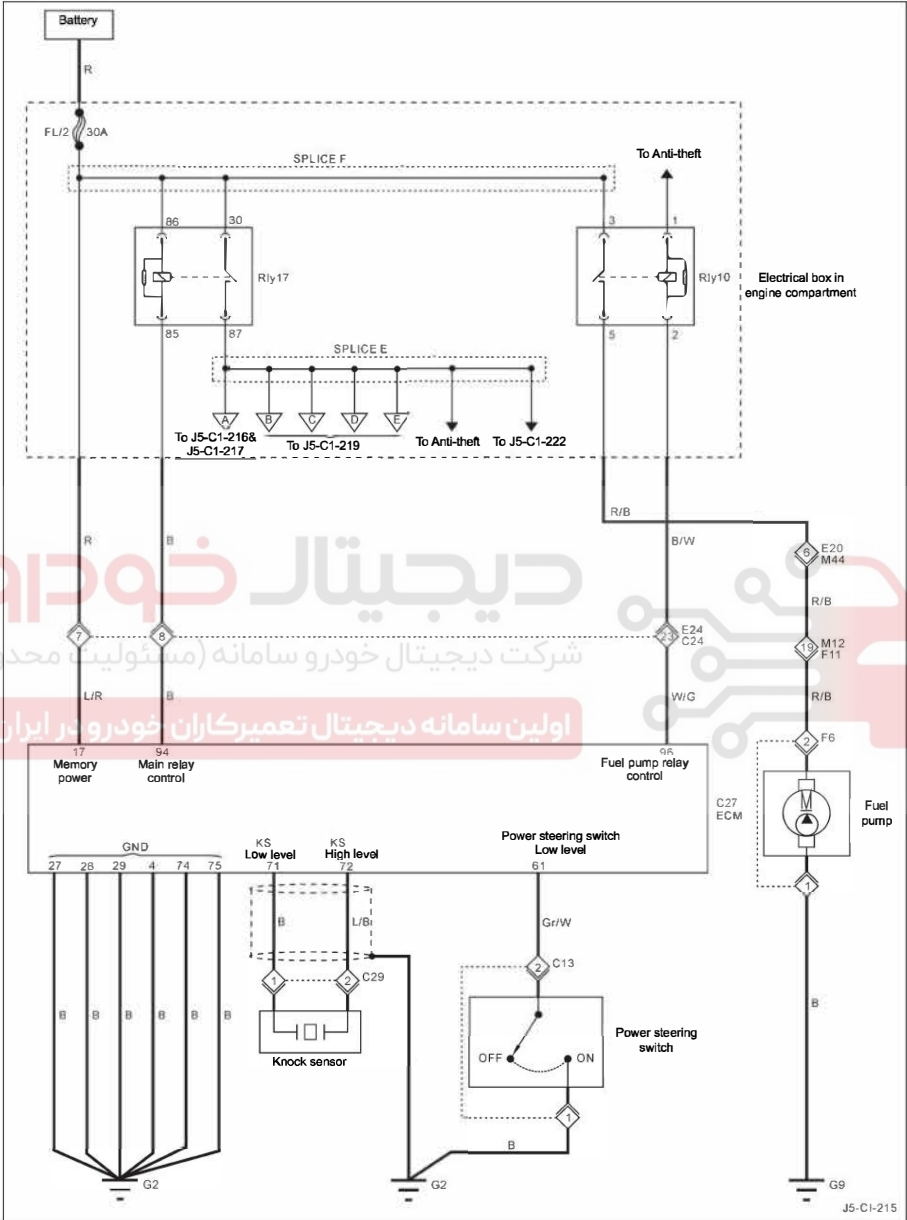

Circuit diagram

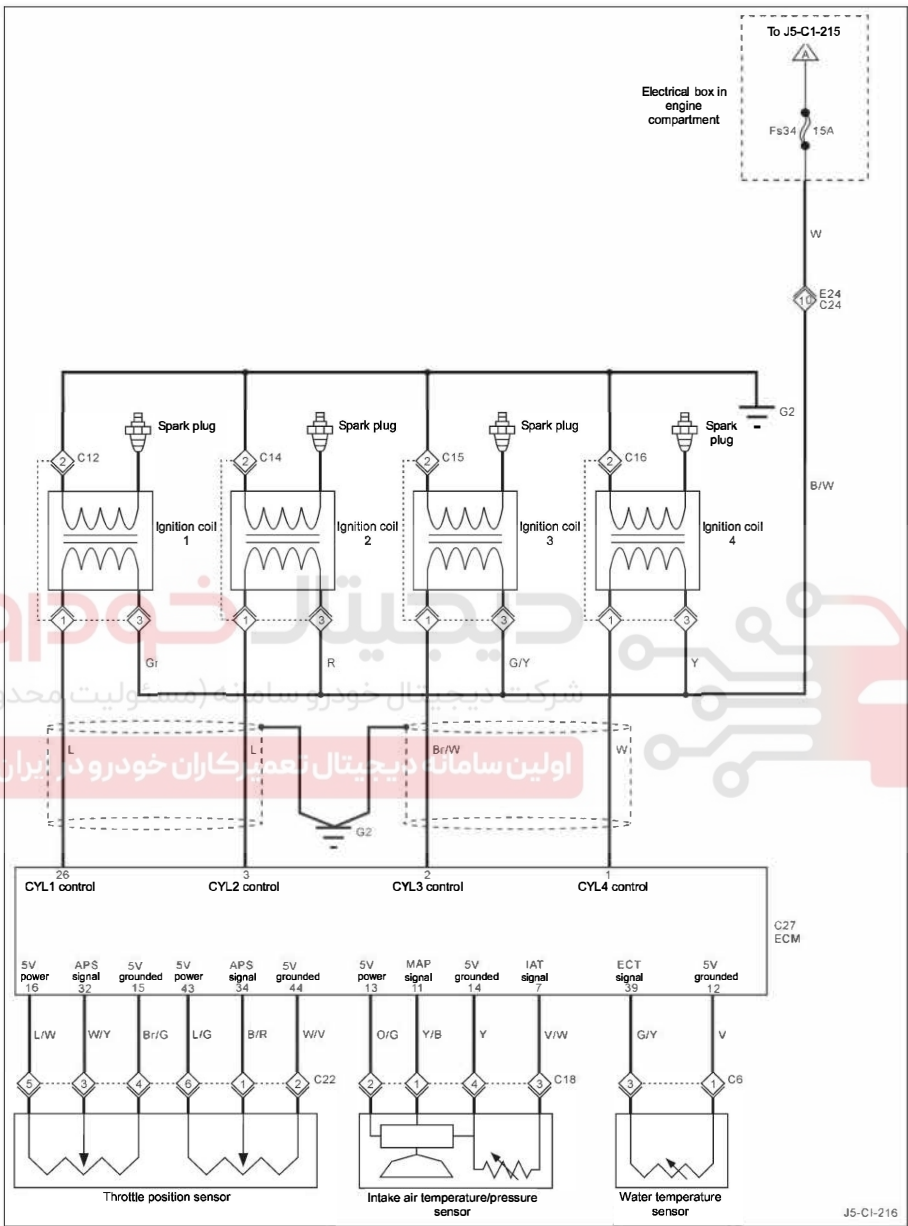

Circuit diagram

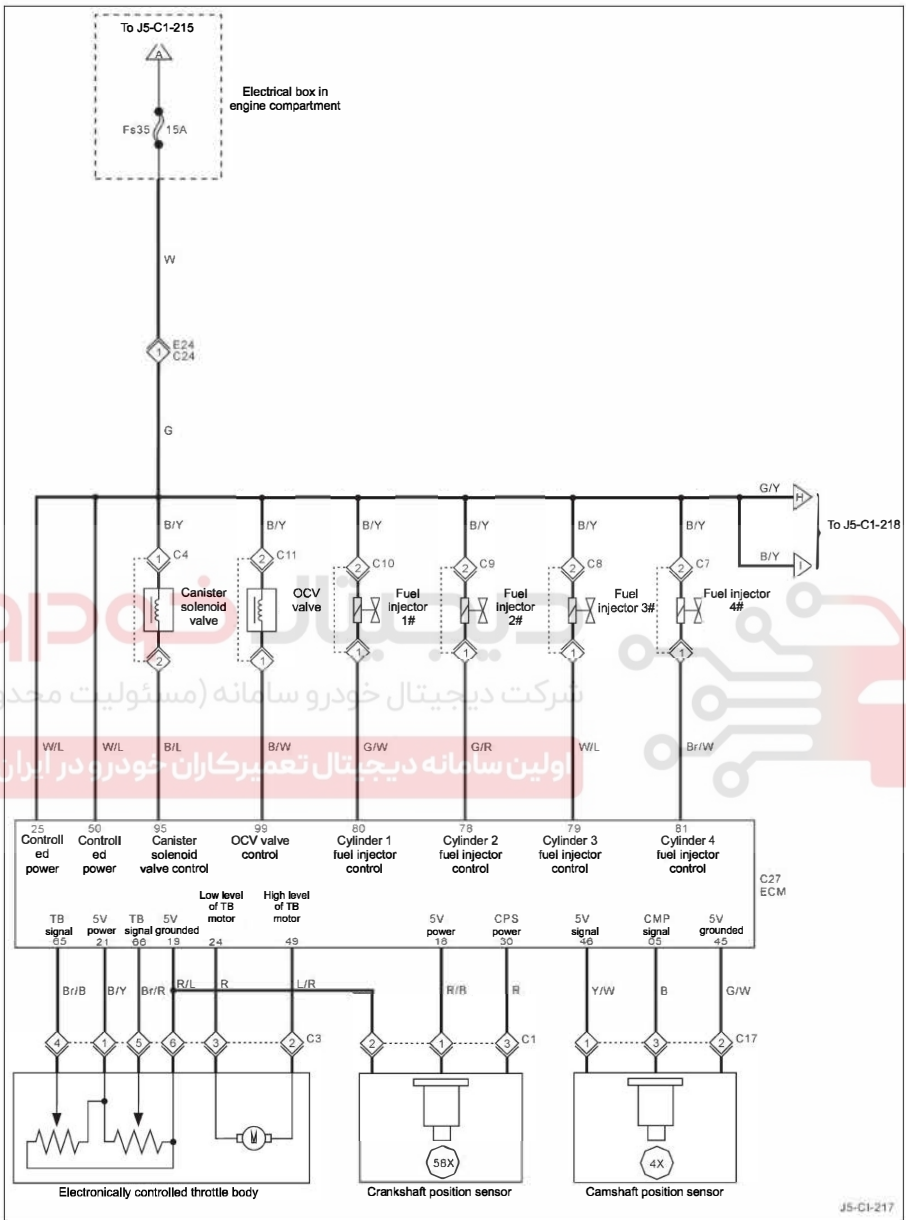

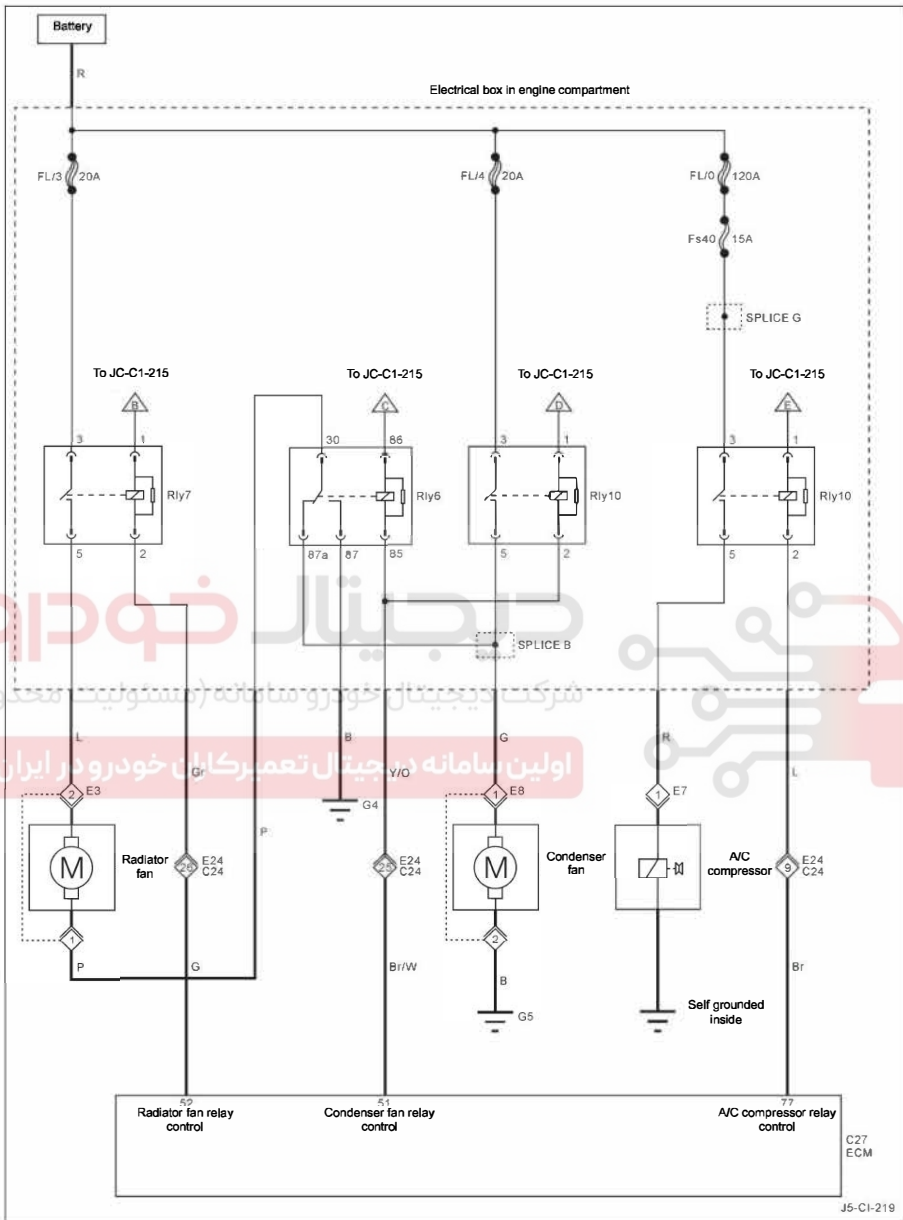

◇ harness plug

No.	No.	Description of harness plug
C24	E24	Engine control harness –engine harness (on the right of brake oil tank)
C26	M2	Engine control harness – main harness (below and on the right of dashboard)
E20	M44	Engine harness – main harness (below and on the left of dashboard)
M12	F11	Main harness – vehicle frame harness (below and on the left of dashboard)

□: switch and electrical device

No.	Description	Position
C1	To crankshaft position sensor	Engine control harness
C3	To electronically controlled throttle body	Engine control harness
C4	To canister solenoid valve	Engine control harness
C5	To front oxygen sensor	Engine control harness
C6	To water temperature sensor	Engine control harness
C7	To Cylinder 4 fuel injector	Engine control harness
C8	To Cylinder 3 fuel injector	Engine control harness
C9	To Cylinder 2 fuel injector	Engine control harness
C10	To Cylinder 1 fuel injector	Engine control harness
C11	To OCV valve	Engine control harness
C12	To Cylinder 1 ignition coil	Engine control harness
C13	To power steering switch	Engine control harness
C14	To Cylinder 2 ignition coil	Engine control harness
C15	To Cylinder 3 ignition coil	Engine control harness
C16	To Cylinder 4 ignition coil	Engine control harness
C17	To camshaft position sensor	Engine control harness
C18	To intake air pressure/temperature sensor	Engine control harness
C19	To vehicle speed sensor	Engine control harness
C22	To throttle position sensor	Engine control harness
C23	To rear oxygen sensor	Engine control harness
C27	To ECM	Engine control harness
C29	To shock sensor	Engine control harness
E3	To radiator fan	Engine harness
E7	To A/C compressor	Engine harness
E8	To condenser fan	Engine harness

No.	Description	Position
E22	To interior electrical box (I/P-D)	Engine harness
F6	To fuel pump	Vehicle frame harness
M14	To interior electrical box (I/P-k)	Main harness

دیجیتال خودرو

شرکت دیجیتال خودرو سامانه (مسئولیت محدود)

اولین سامانه دیجیتال تعمیرکاران خودرو در ایران



Combined instrument

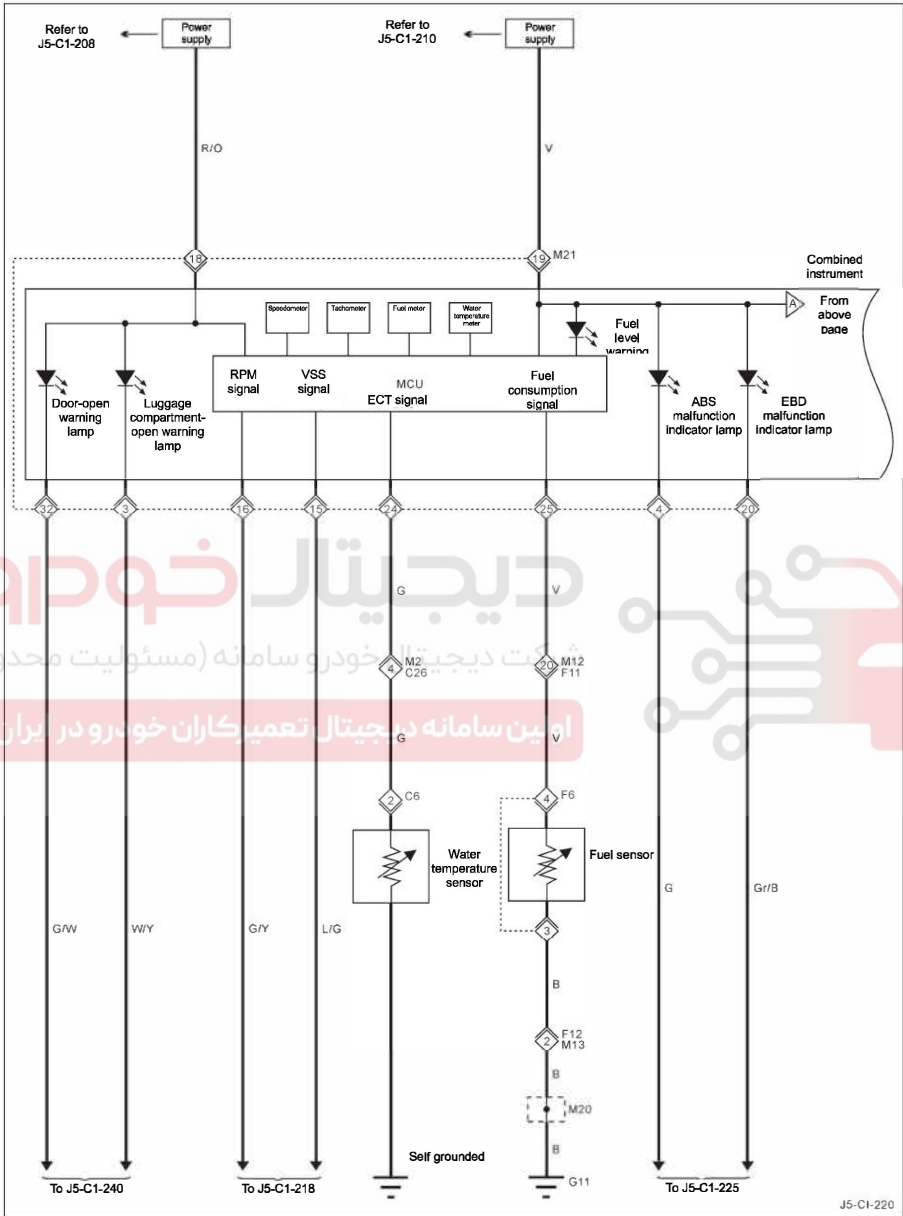

J5-C1-220

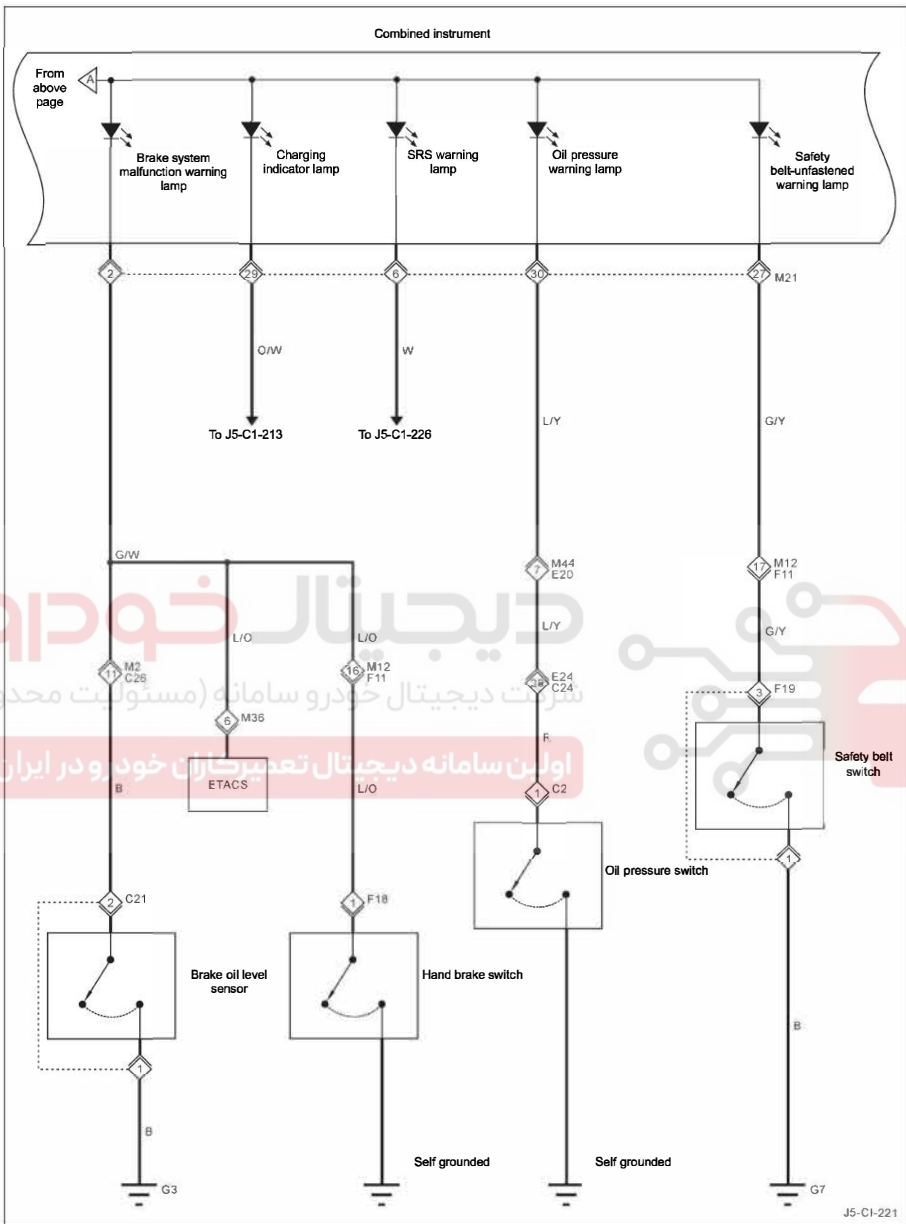

دیجیتال خودرو (مستولیت محدود)
اولین سامانه دیجیتال تعمیرکاران خودرو در ایران

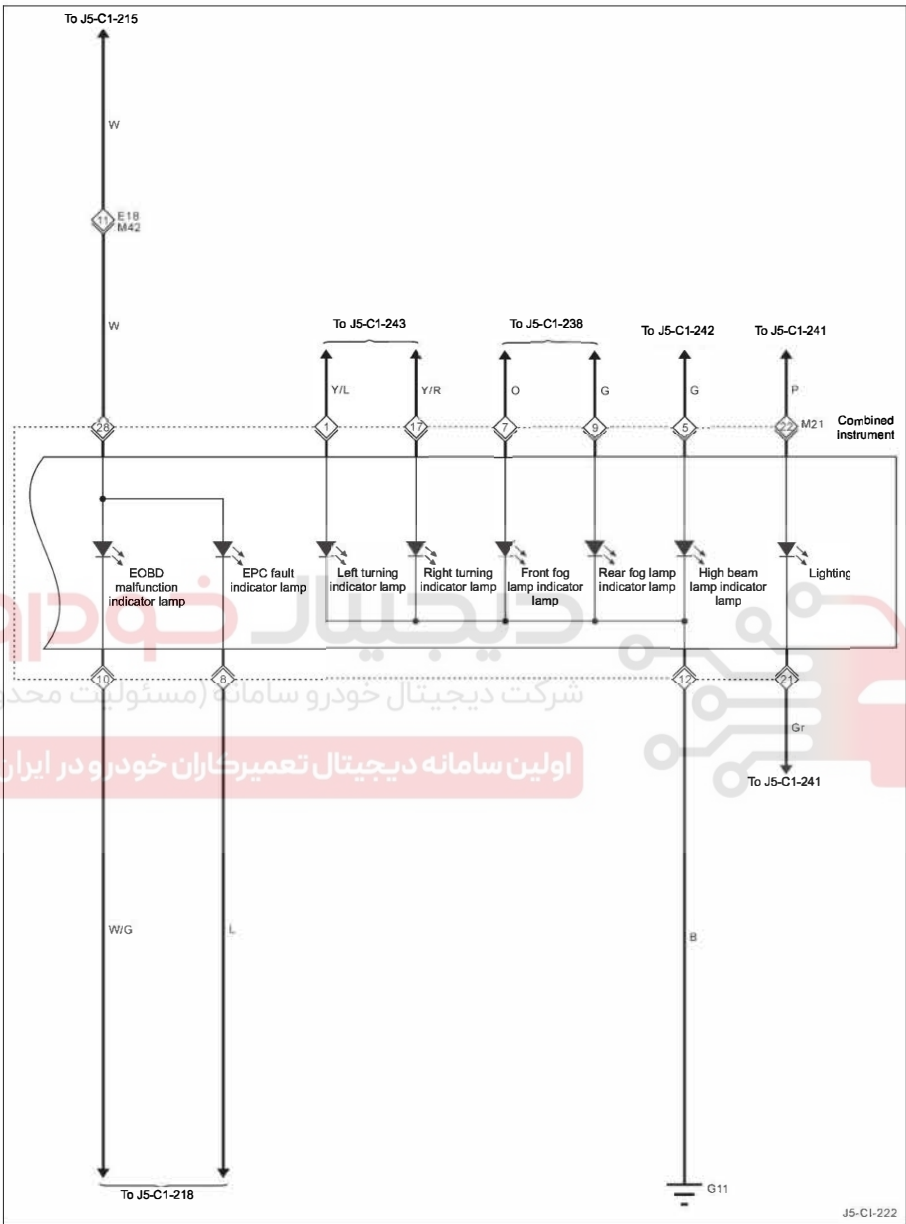

◇: harness plug

No.	No.	Description of harness plug
C24	E24	Engine control harness –engine harness (near the brake oil tank)
C26	M2	Engine control harness – main harness (below and on the right of dashboard)
E18	M42	Engine harness – main harness (below and on the left of dashboard)
E20	M44	Engine harness – main harness (below and on the left of dashboard)
M12	F11	Main harness – vehicle frame harness (below and on the left of dashboard)
M13	F12	Main harness –vehicle frame harness (below and on the left of dashboard)

□: switch and electrical device

No.	Description	Position
C2	To oil pressure sensor	Engine control harness
C6	To water temperature sensor	Engine control harness
C21	To brake oil level sensor	Engine control harness
F6	To fuel pump	Vehicle frame harness
F18	To hand brake switch	Vehicle frame harness
F19	To safety belt switch	Vehicle frame harness
M21	To combined instrument	Main harness
M36	To ETACS	Main harness

Electronic information and time control system (ETAS)

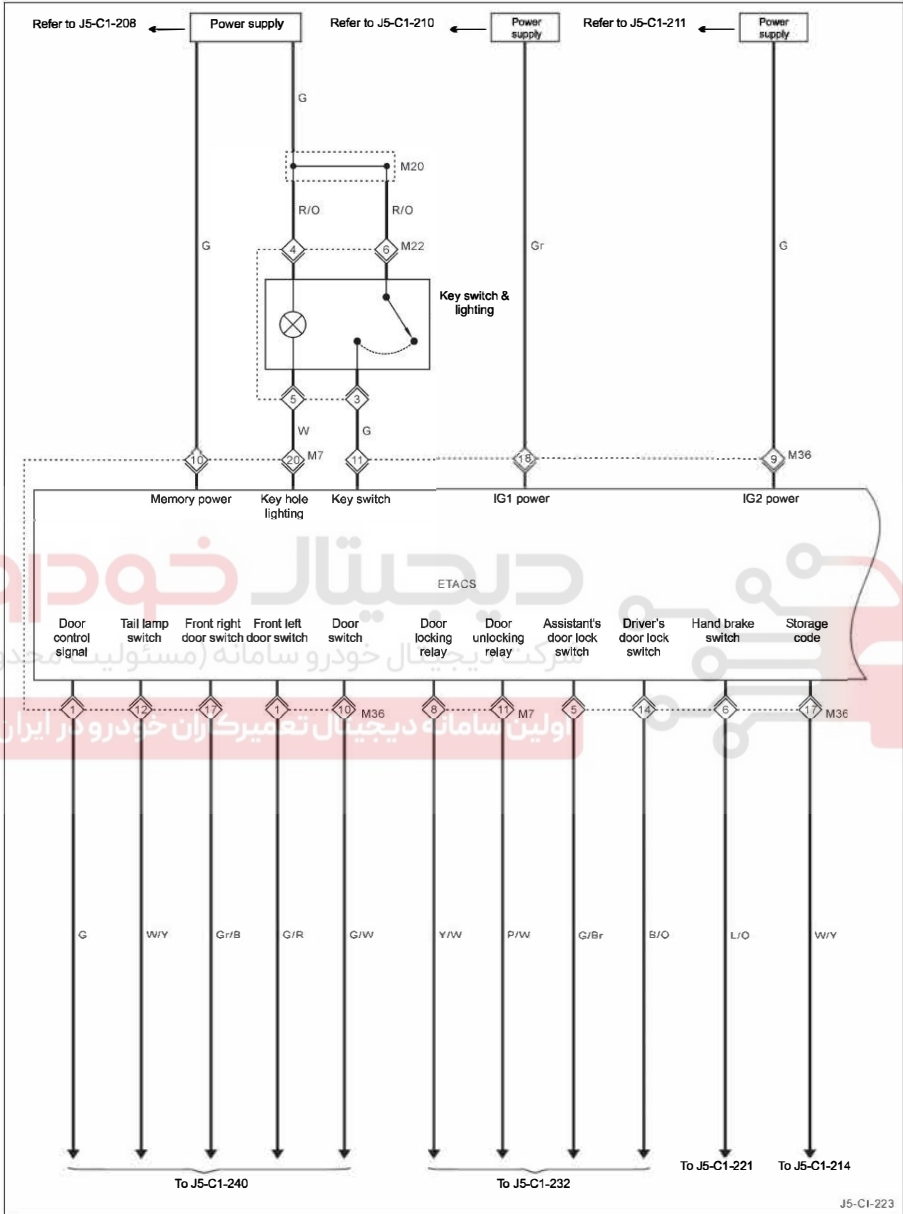

Circuit diagram

CI - 49

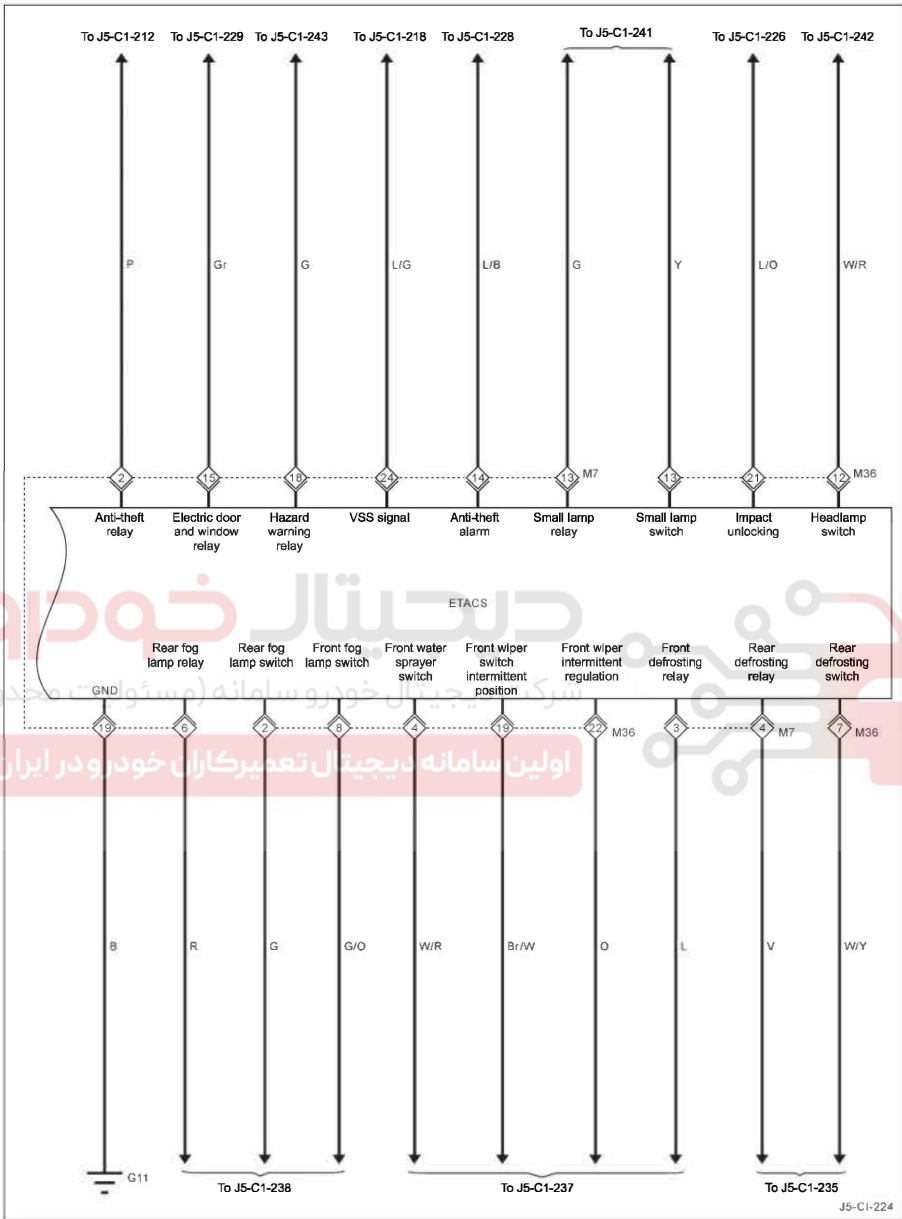

□: switch and electrical device

No.	Description	Position
M7	To ETACS	Main harness
M20	To short-circuiter	Main harness
M22	To key switch	Main harness
M36	To ETACS	Main harness

دیجیتال خودرو

شرکت دیجیتال خودرو سامانه (مسئولیت محدود)

اولین سامانه دیجیتال تعمیرکاران خودرو در ایران



Anti-lock brake system (ABS)

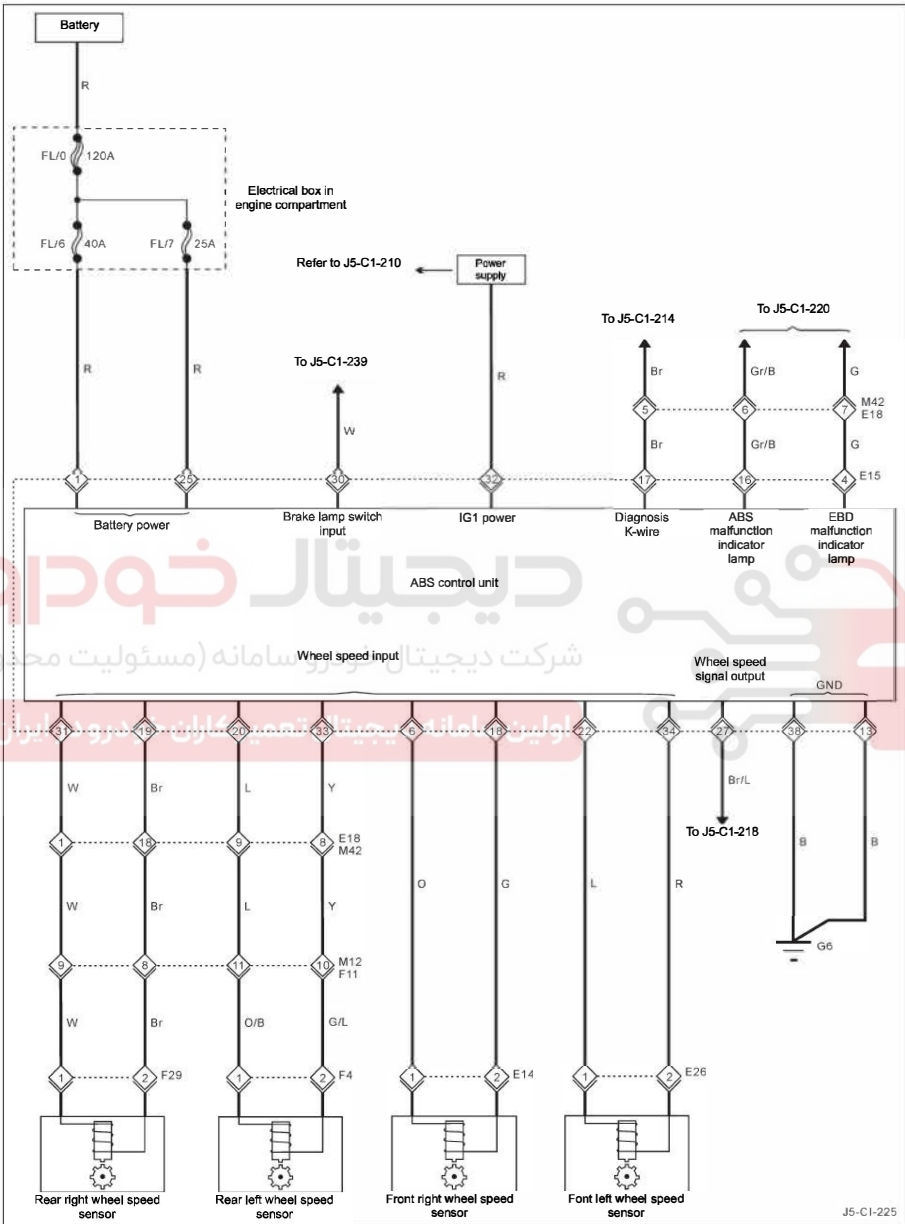

J5-C1-225

◇: harness plug

No.	No.	Description of harness plug
E18	M42	Engine harness – main harness (below and on the left of dashboard)
M12	F11	Main harness – vehicle frame harness (below and on the left of dashboard)

□: switch and electrical device

No.	Description	Position
E14	To front right wheel speed sensor	Engine harness
E15	To ABS control unit	Engine harness
E26	To front left wheel speed sensor	Engine harness
F4	To rear left wheel speed sensor	Vehicle frame harness
F29	To rear right wheel speed sensor	Vehicle frame harness

دیجیتال خودرو

شرکت دیجیتال خودرو سامانه (مسئولیت محدود)

اولین سامانه دیجیتال تعمیرکاران خودرو در ایران

