

سیستم کنترل پاشش سوخت چند نقطه ای

سیستم کنترل پاشش سوخت چند نقطه ای (2) (4FCGAMMA 1.6)

SD313-2

دیگرام مدار کامل

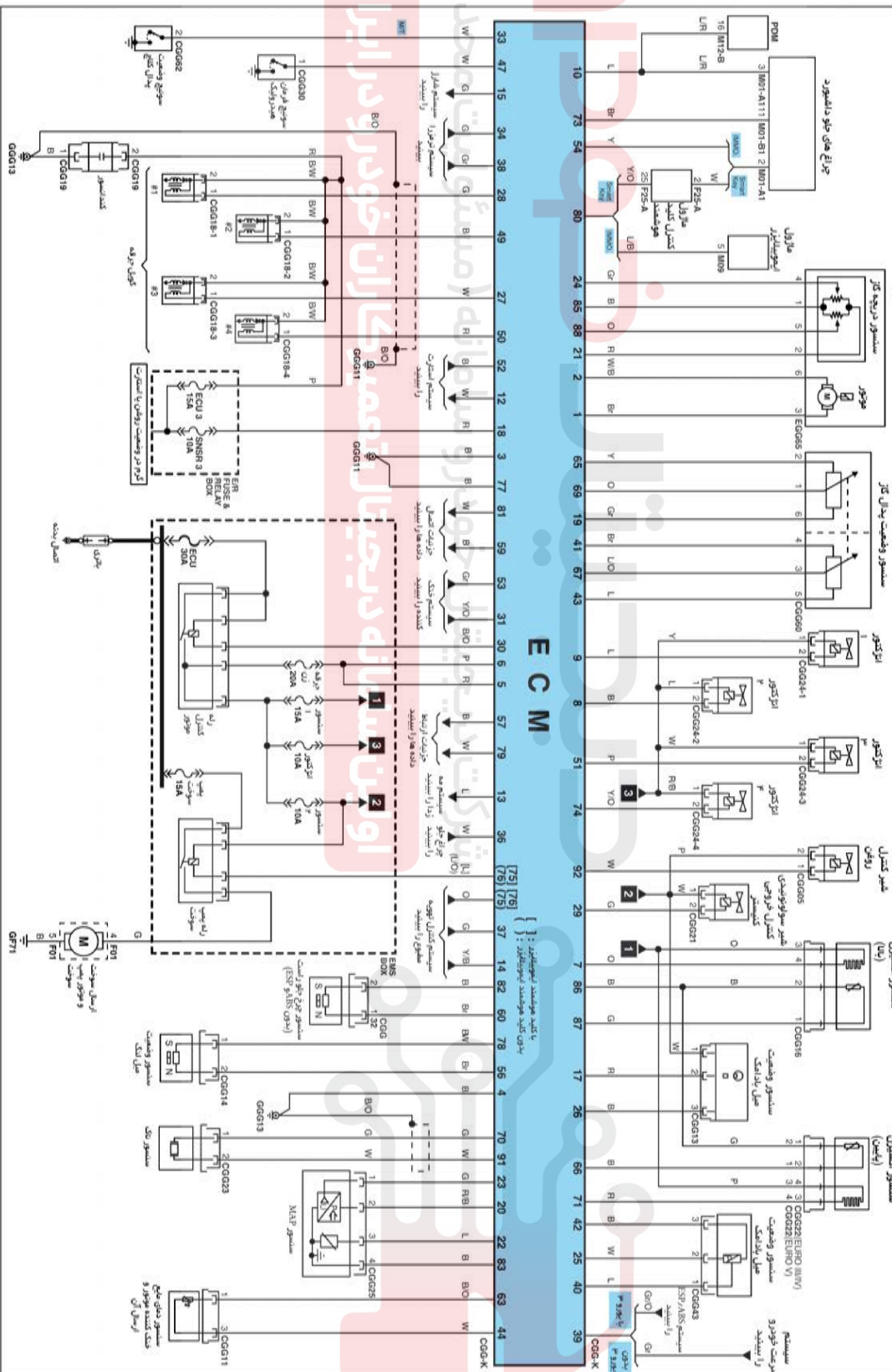

ETDSD11313BL



سیستم کنترل تزریق سوخت چند نقطه‌ای

سیستم کنترل تزریق سوخت چند نقطه‌ای (G4FC-GSL 1.6L)(۳)

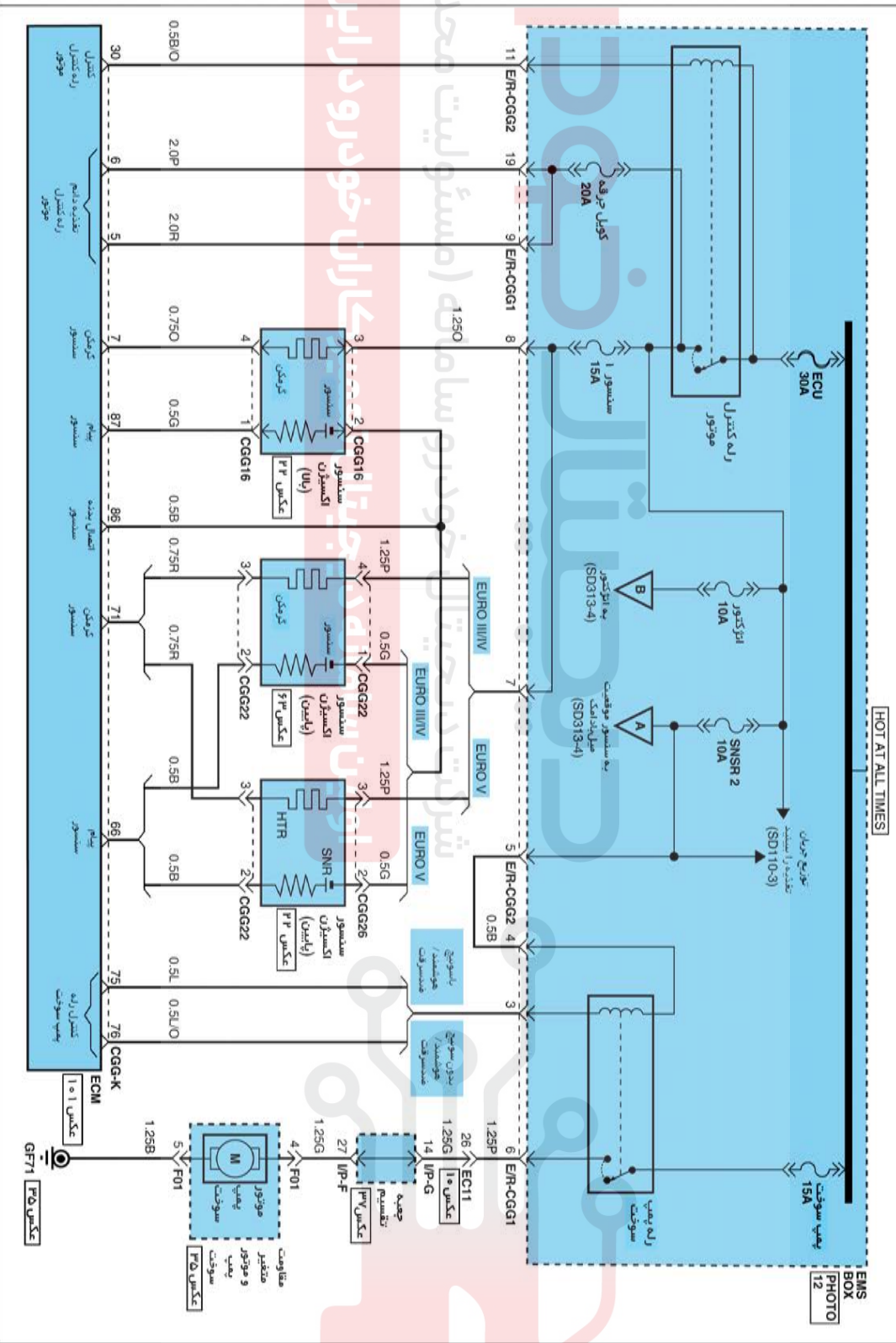

ETDSD11313CL



سیستم کنترل تزریق سوخت چند نقطه‌ای

سیستم کنترل تزریق سوخت چند نقطه‌ای (G4FC-GSL 1.6L) (۵)

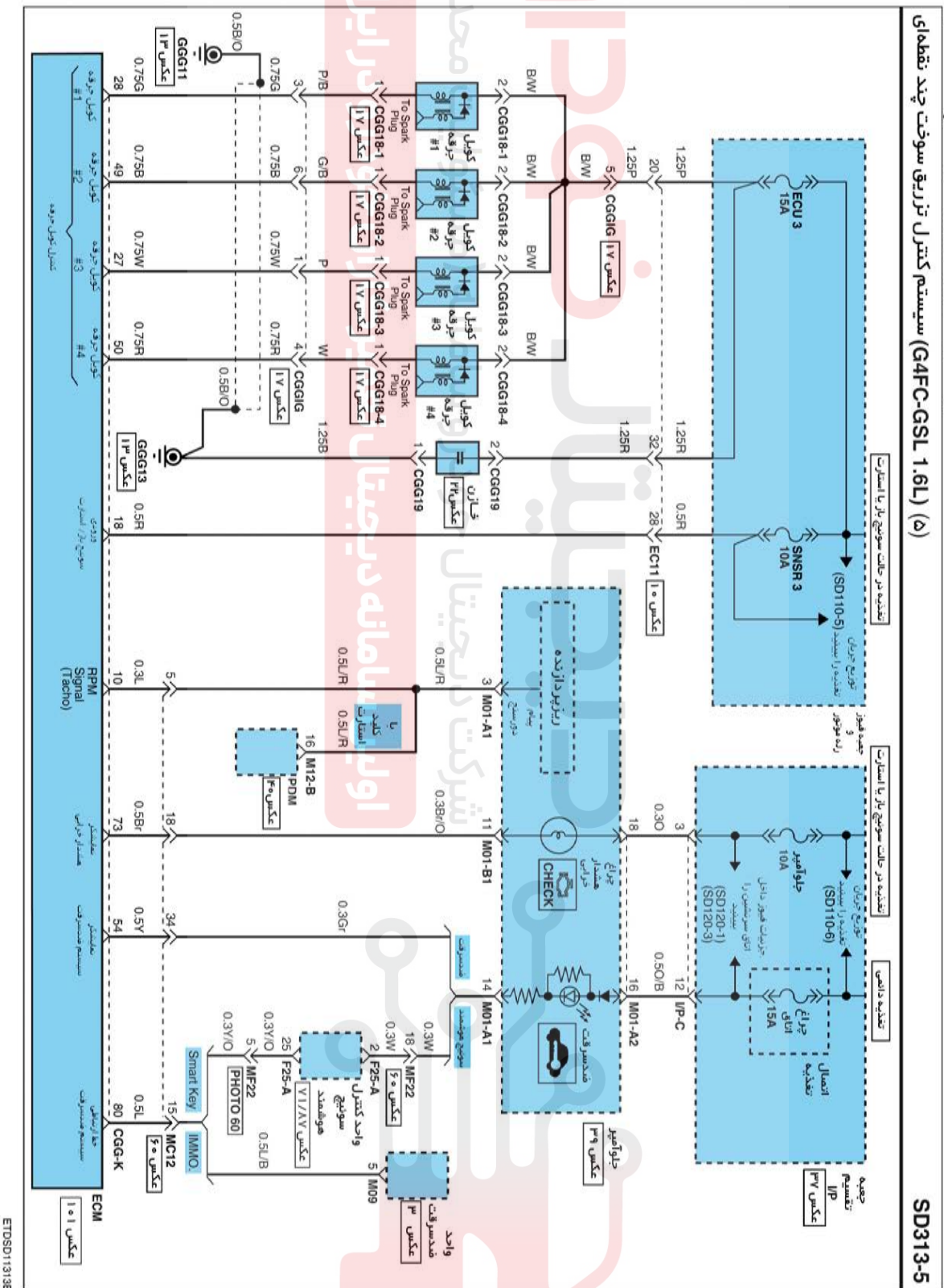

سیستم کنترل تزریق سوخت چند نقطه‌ای

(1) سیستم کنترل تزریق سوخت چند نقطه‌ای (G4K-D-GSL 2.0L)

THETA II 2.0L

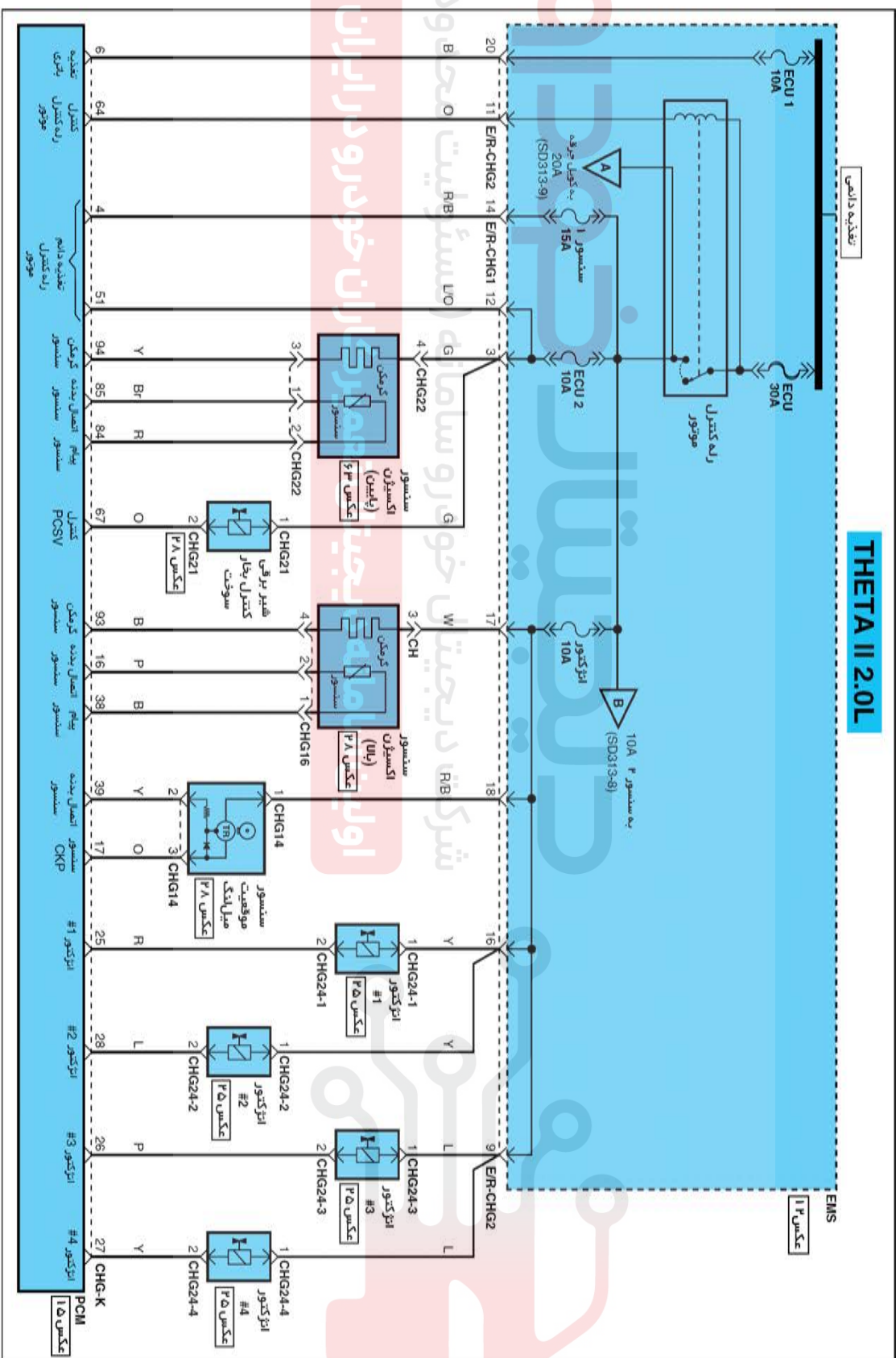

سیستم کنترل تزریق سوخت چند نقطه‌ای

سیستم کنترل تزریق سوخت چند نقطه‌ای (۳)

SD313-9

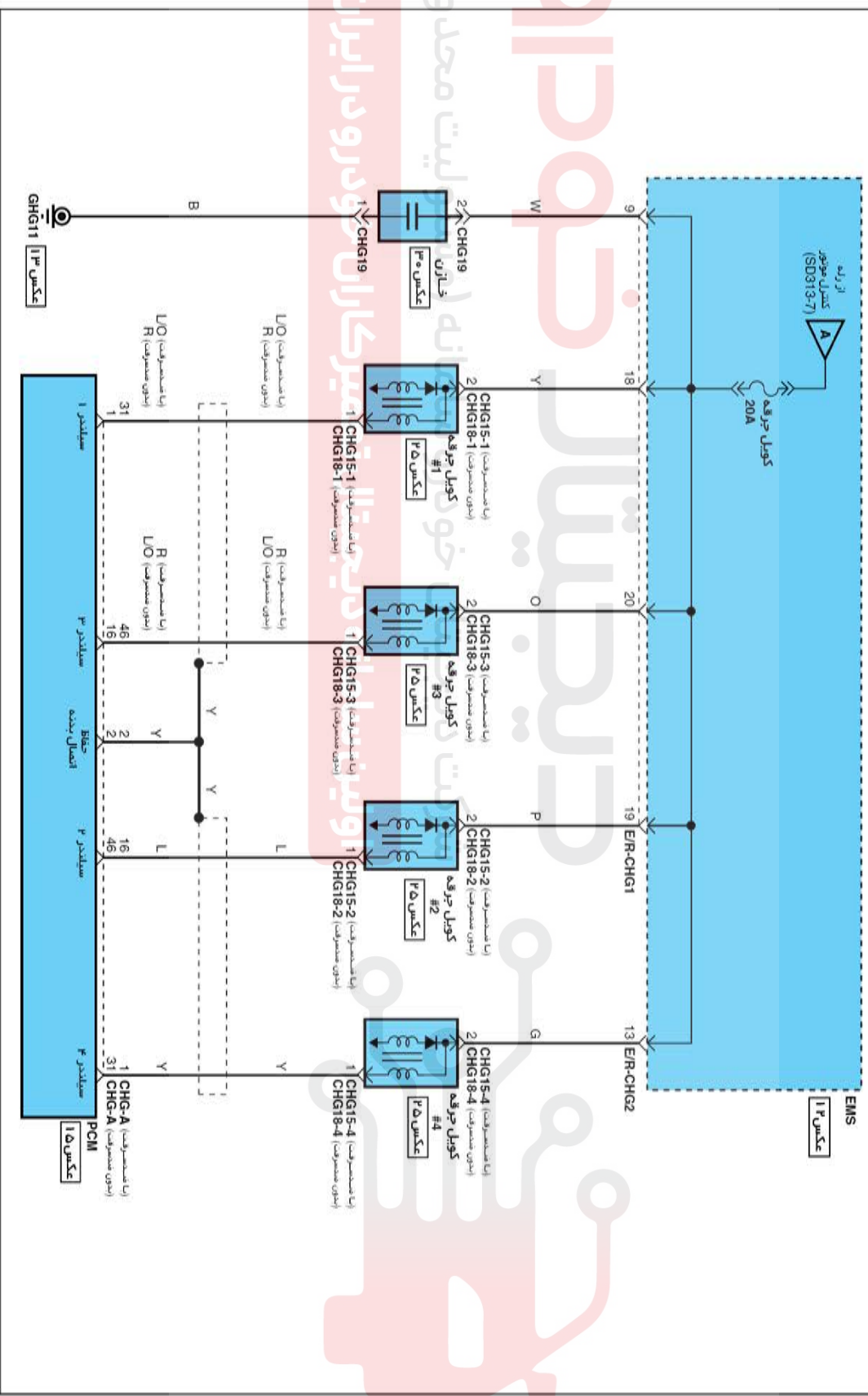

ETDS09313L

سیستم کنترل تزریق سوخت چند نقطه‌ای

SD313-11 سیستم کنترل تزریق سوخت چند نقطه‌ای (G4KD-GSL 2.0L)

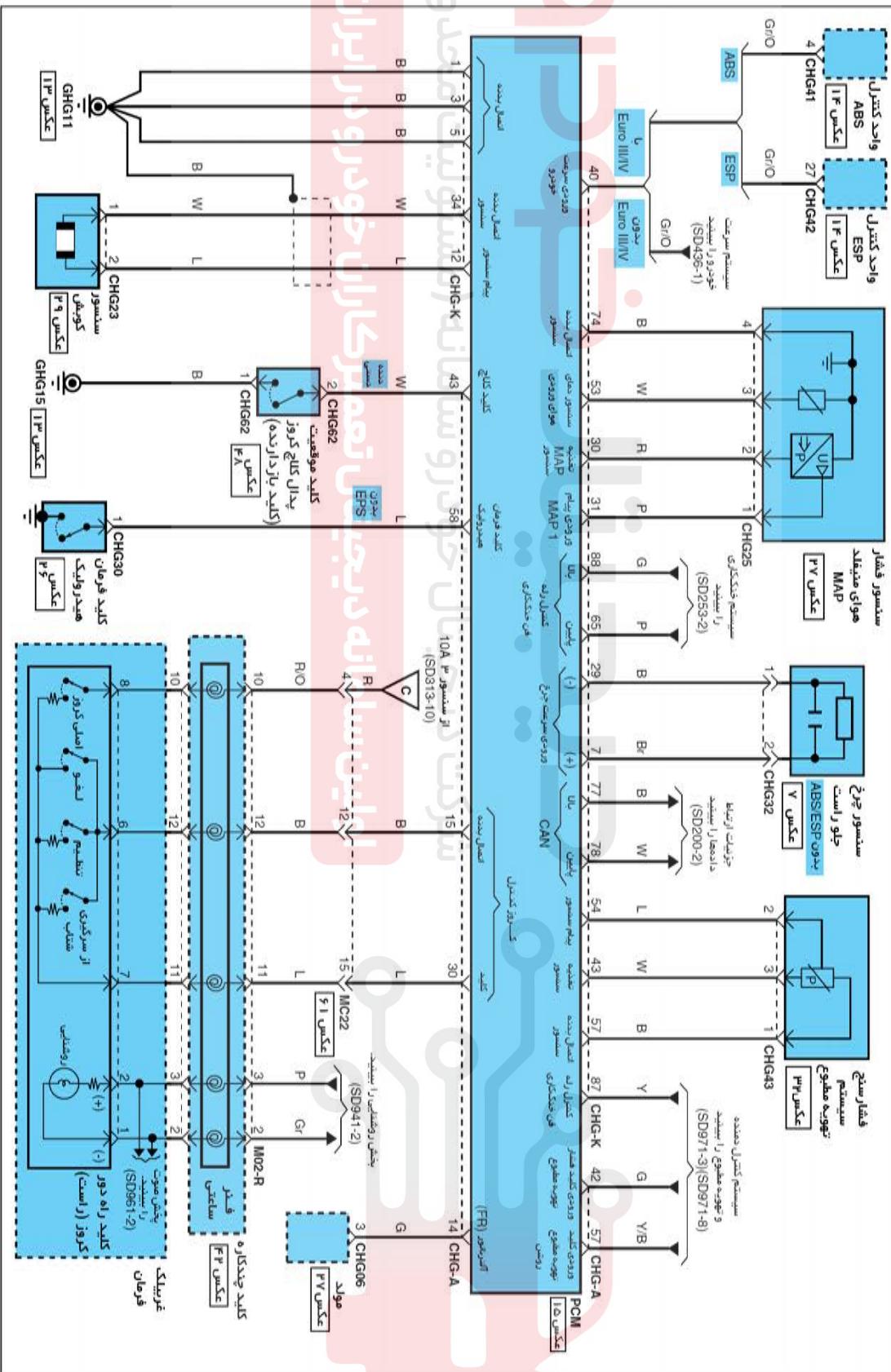

ETDSD9313KL



سیستم کنترل تزریق سوخت چند نقطه‌ای

(۶) سیستم کنترل تزریق سوخت چند نقطه‌ای (G4KD-GSL 2.0L)

SD313-12

CHG-A

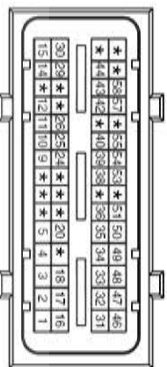

CHG-K

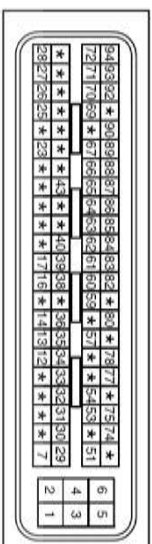

AMP_ECU_50F_B.A

AMP_ECU_94F_B

CHG05



KET_090WP_02F_B.L

CHG06



KET_090WP_03F_B

CHG11

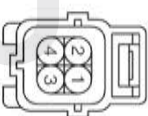

AMP_EWIP_04F_B

CHG12

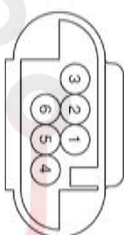

AMP_MOSWP_06F_B_1

CHG13

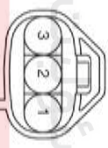

CHG14

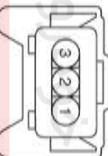

CHG15-1

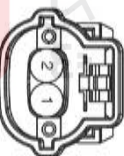

CHG15-2



CHG15-3



CHG15-4

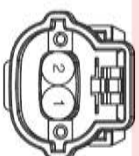

CHG16

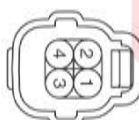

CHG18-1



CHG18-2



CHG18-3



CHG18-4



CHG19



SUM_090WP_02F_G.R.L

AMP_4PT_03F_B_S2

KET_090WP_02F_B.L3

KET_090WP_02F_B.L3

KET_090WP_02F_B.L3

KET_090WP_02F_B.L3

KET_090WP_04F_B

KET_090WP_02F_B.L3

KET_090WP_02F_B.L3

KET_090WP_02F_B.L3

KET_090WP_02F_B.L3







MLX_090CIGAR_02F_B

ETDSD9313LL

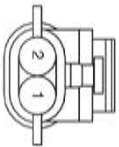
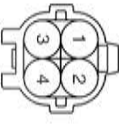
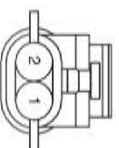
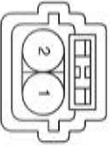
سیستم کنترل تزریق سوخت چند نقطه‌ای

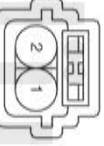
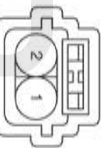
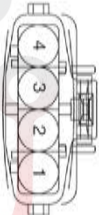
(۷) سیستم کنترل تزریق سوخت چند نقطه‌ای (G4KD-GSL 2.0L)

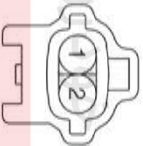
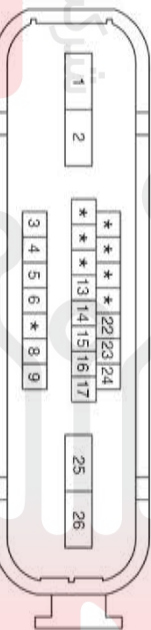
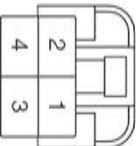
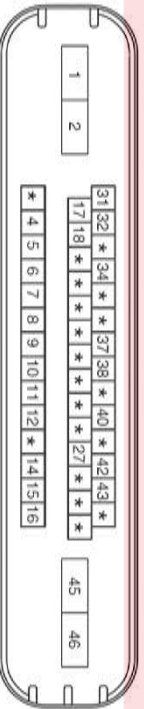
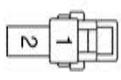
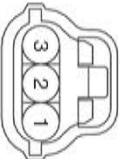
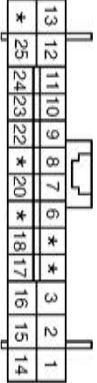
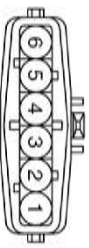
SD313-13

<p>CHG21</p>  <p>PKD_MP150_02F_B</p>	<p>CHG22</p>  <p>KET_SMP_04M_B</p>	<p>CHG23</p>  <p>PKD_150WP_02F_GR</p>	<p>CHG24-1</p>  <p>KUM_NDWP_02F_Gr</p>
<p>CHG24-2</p>  <p>KUM_NDWP_02F_Gr</p>	<p>CHG24-3</p>  <p>KUM_NDWP_02F_Gr</p>	<p>CHG24-4</p>  <p>KUM_NDWP_02F_Gr</p>	<p>CHG25</p>  <p>AMP_JPT_04F_B BOSCH</p>
<p>CHG30</p>  <p>KUM_NMWP_01F_B</p>	<p>CHG32</p>  <p>KUM_NDWP_02M_B</p>	<p>CHG41</p>  <p>AMP_ABS_26F_B</p>	<p>CHG53</p>  <p>AMP_2500L_04F_W</p>
<p>CHG42</p>  <p>KUM_NMWP_01F_B</p>	<p>CHG62</p>  <p>KET_2500L_02F_W</p>	<p>CHG43</p>  <p>KET_040WP_03F_B</p>	<p>F25-A</p>  <p>AMP_0407_26F_W_HD</p>
<p>CHG60</p>  <p>AMP_JPT_06F_B</p>	<p>F01</p>  <p>KET_0900WP_05F_Gr_2</p>	<p>ETDSD9313MIL</p>	



سیستم کنترل تزریق سوخت چند نقطه‌ای

SD313-14 سیستم کنترل تزریق سوخت چند نقطه‌ای (A)

<p>M01-A1</p> <p>AMP_0400M2_16F_W</p>	<p>M01-A2</p> <p>AMP_0400M2_20F_B</p>	<p>M01-B1</p> <p>AMP_0400M1_20F_B</p>	<p>M12-B</p> <p>KET_0400M1_20F_W</p>
<p>M02-R</p> <p>AMP_0205_12F_W</p>	<p>M09</p> <p>KUMI_CDR_05F_W</p>	<p>خالی</p>	<p>خالی</p>

شرکت دیجیتال خودرو سامانه (مسئولیت محدود)

اولین سامانه دیجیتال تمیرکاران خودرو در ایران

