

Circuit Diagram

CAN Bus (Page 1 of 2)

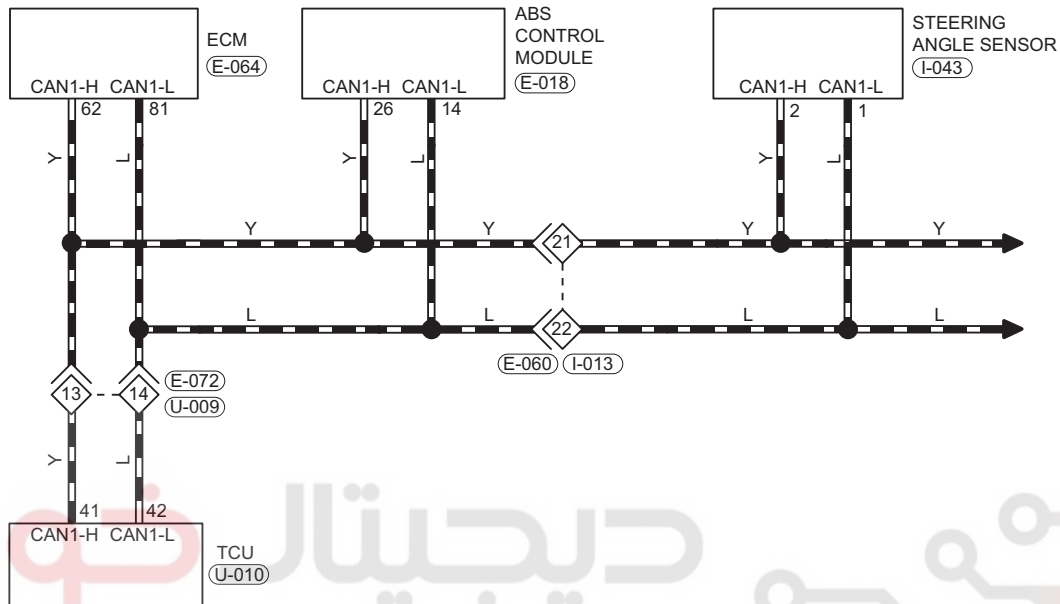

65

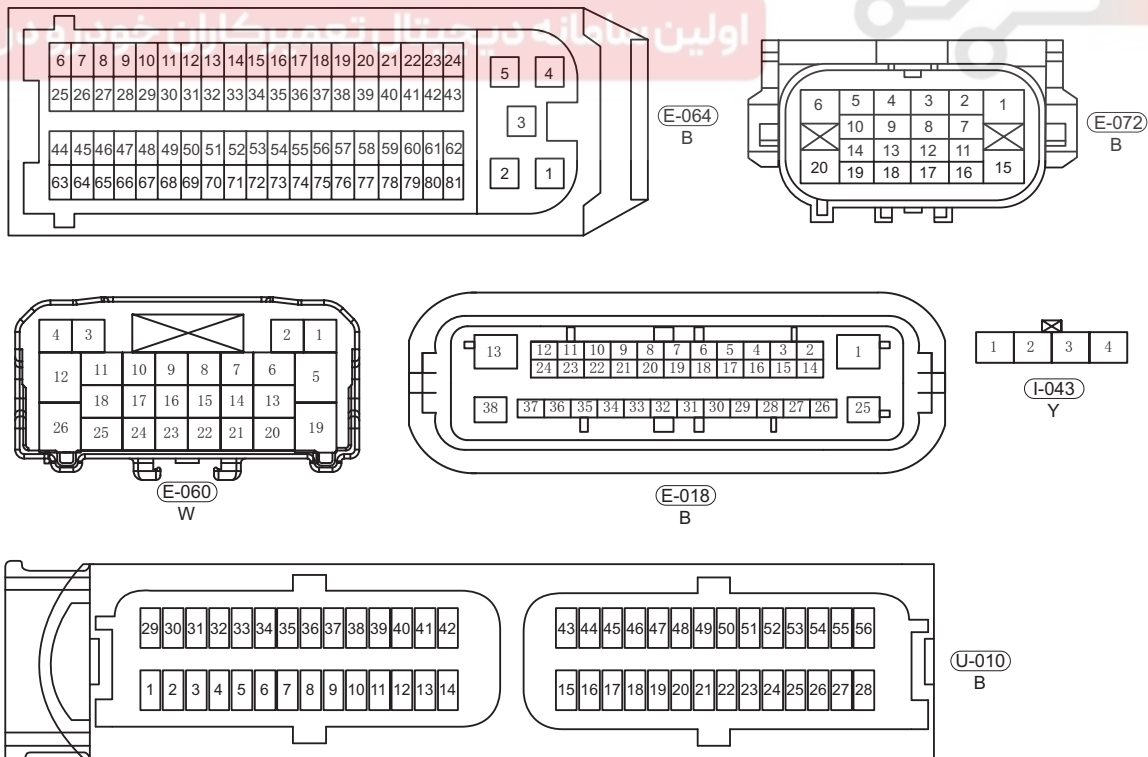

ET11520001

CAN Bus (Page 2 of 2)

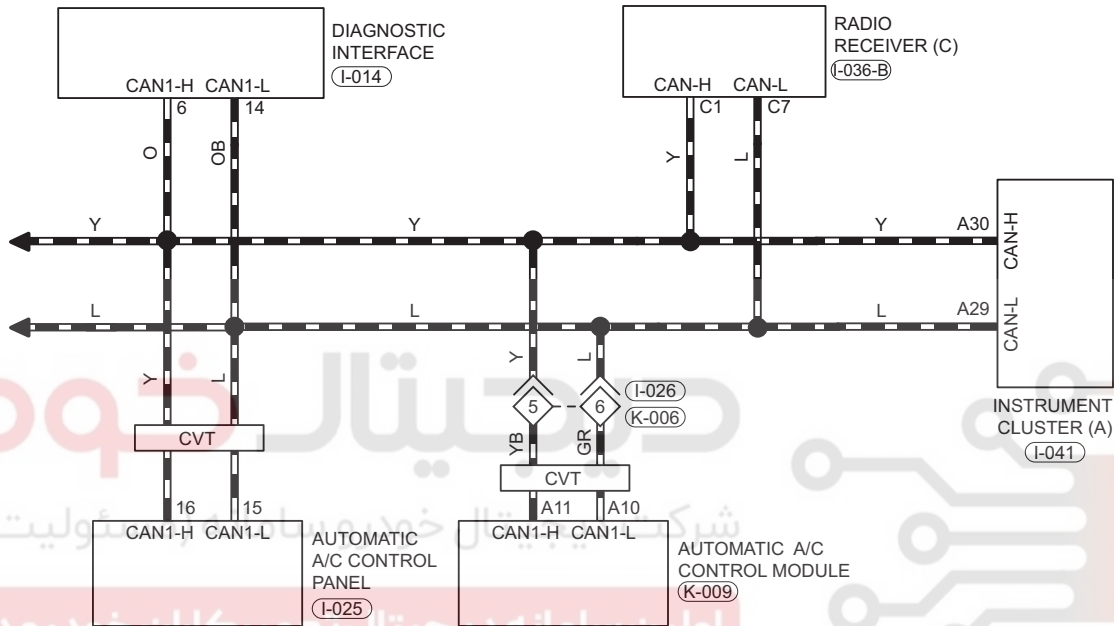

65

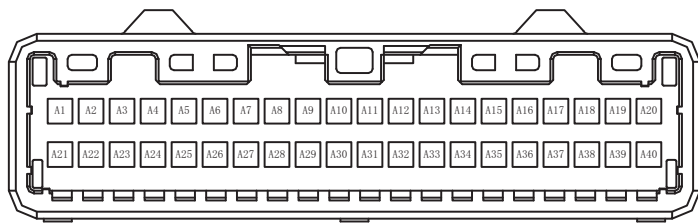

K-009 W

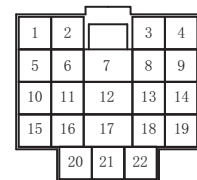

K-006 Lg

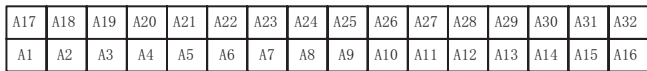

I-041 L

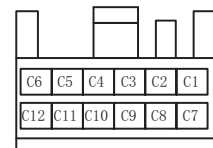

I-036-B L

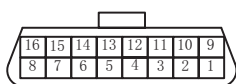

I-014 B

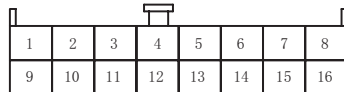

I-025 B

ET11520002