

- \* 1 : New Zealand, Hong Kong, Brazil, Chile
- \* 6 : Before Mar. 2012 Production
- \* 7 : From Mar. 2012 Production
- \* 10 : w/ Dynamic Radar Cruise Control

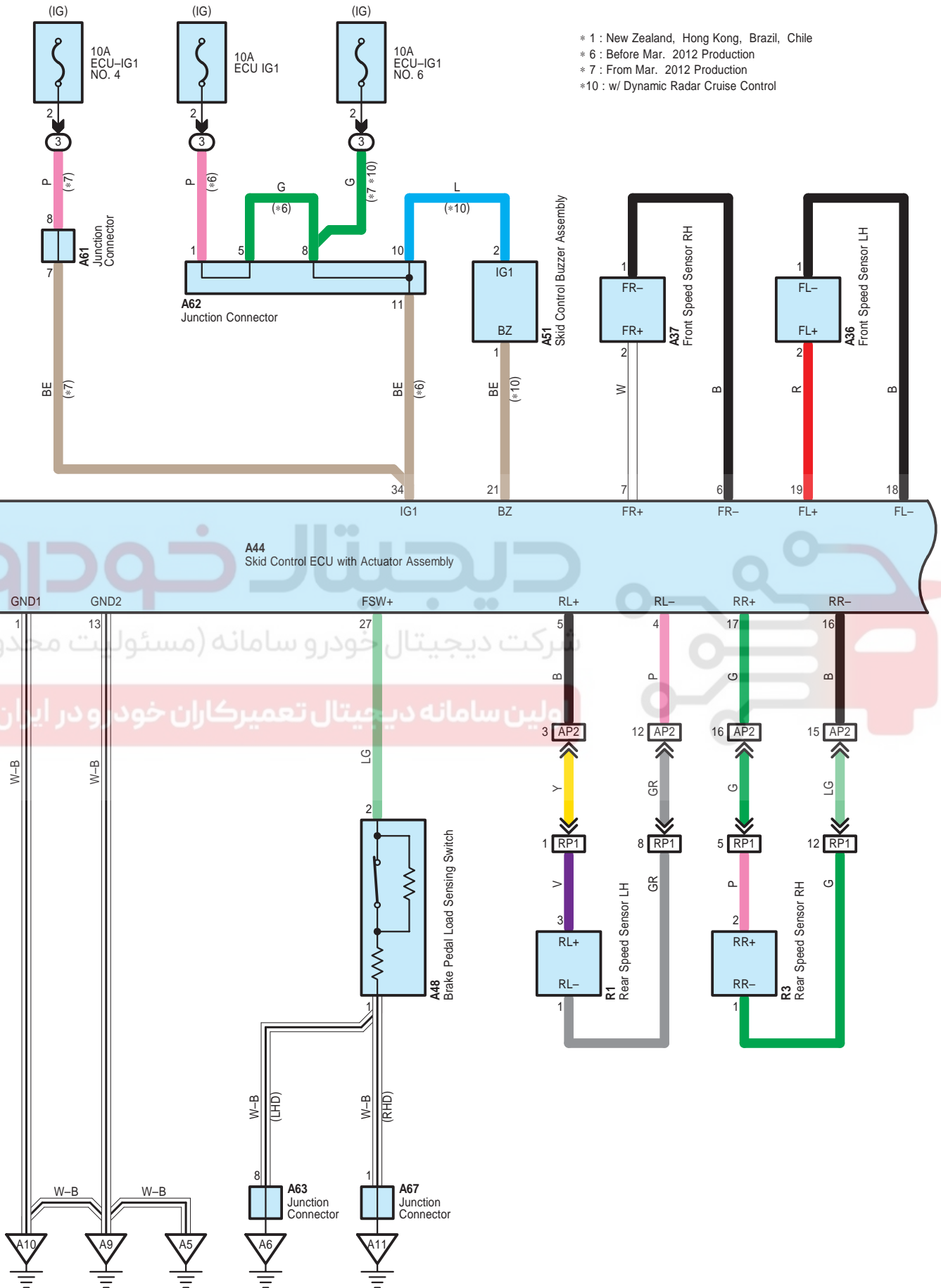

- \* 3 : 2GR-FE
- \* 4 : 1AR-FE
- \* 8 : w/ Paddle Shift
- \* 9 : w/o Paddle Shift

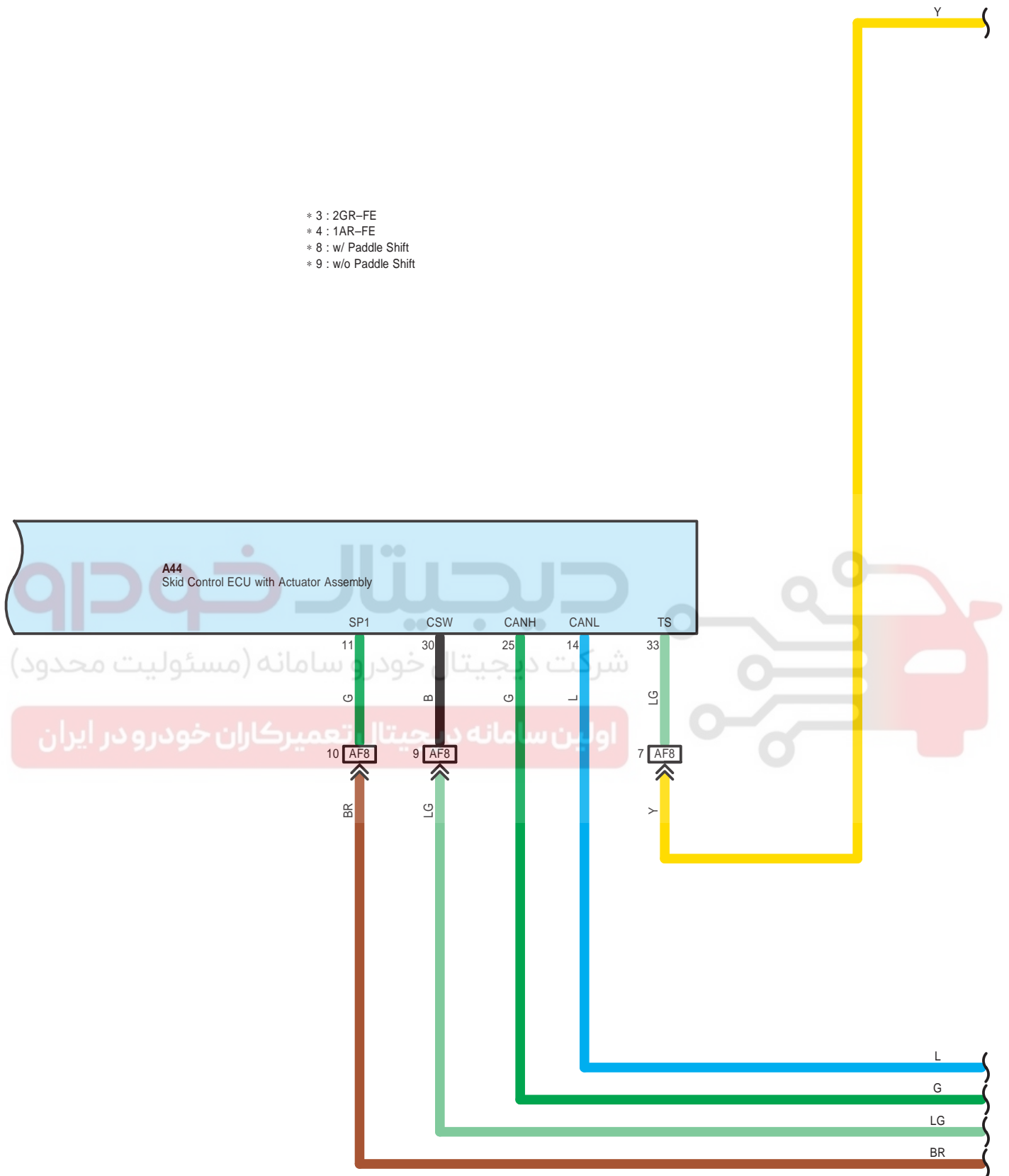

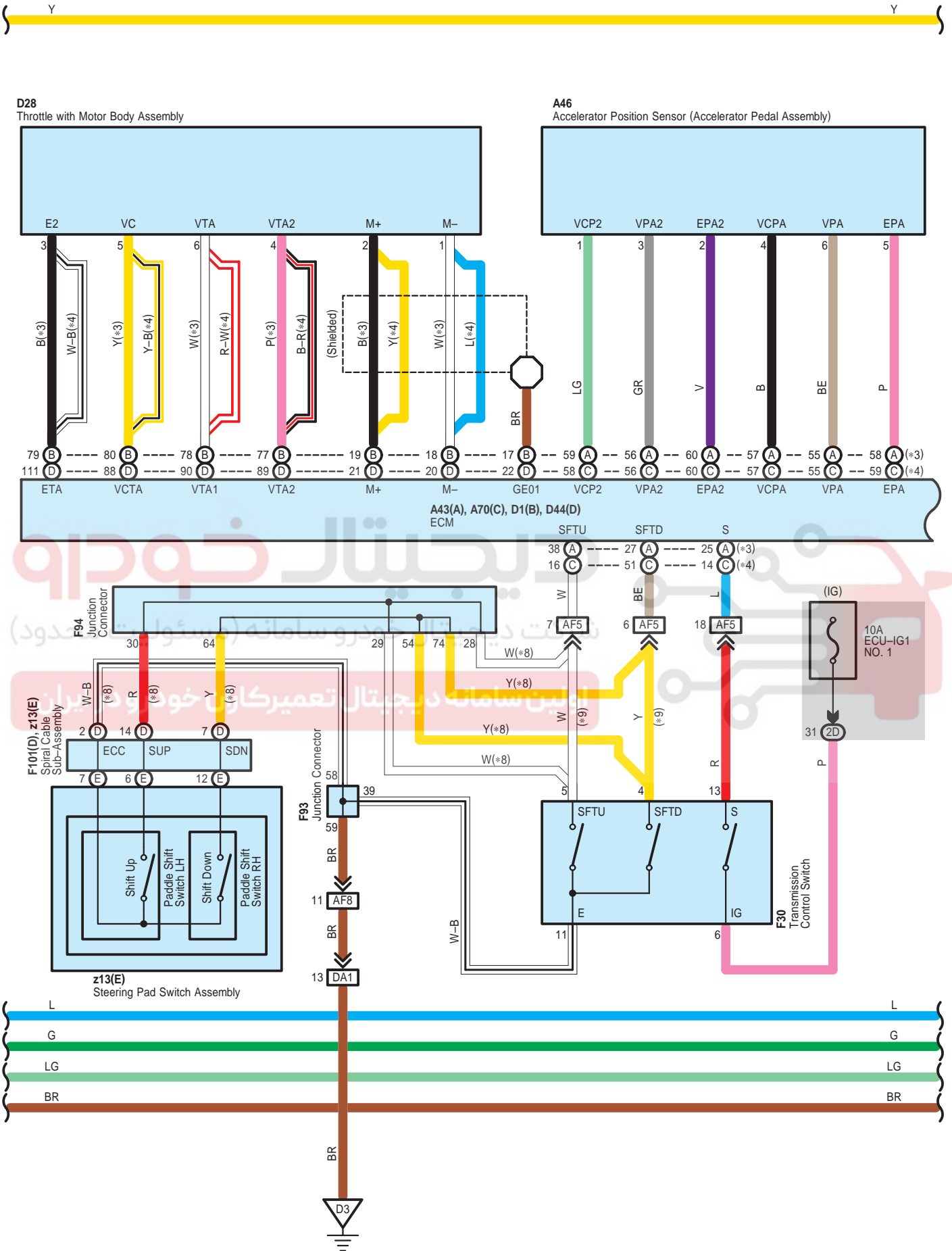



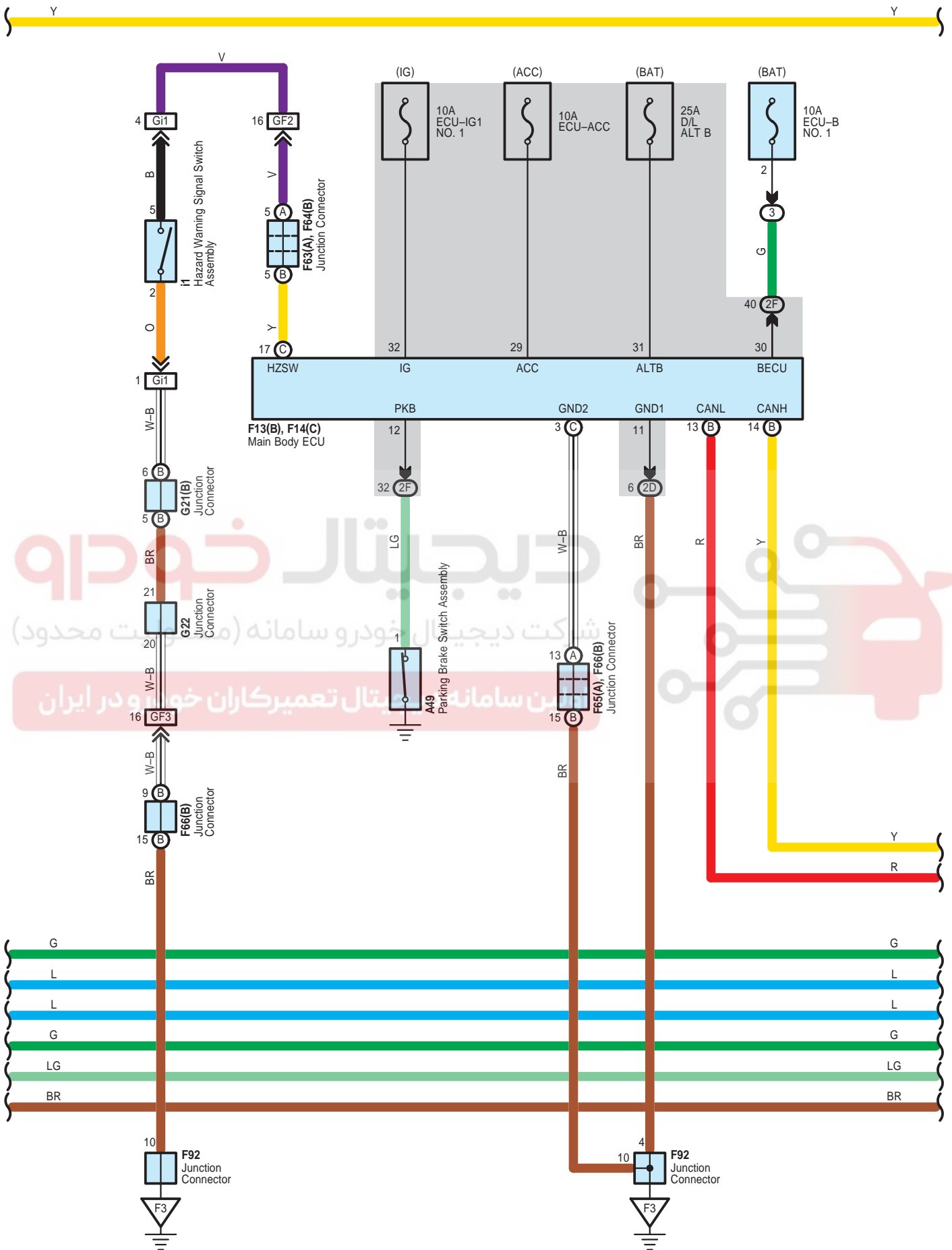

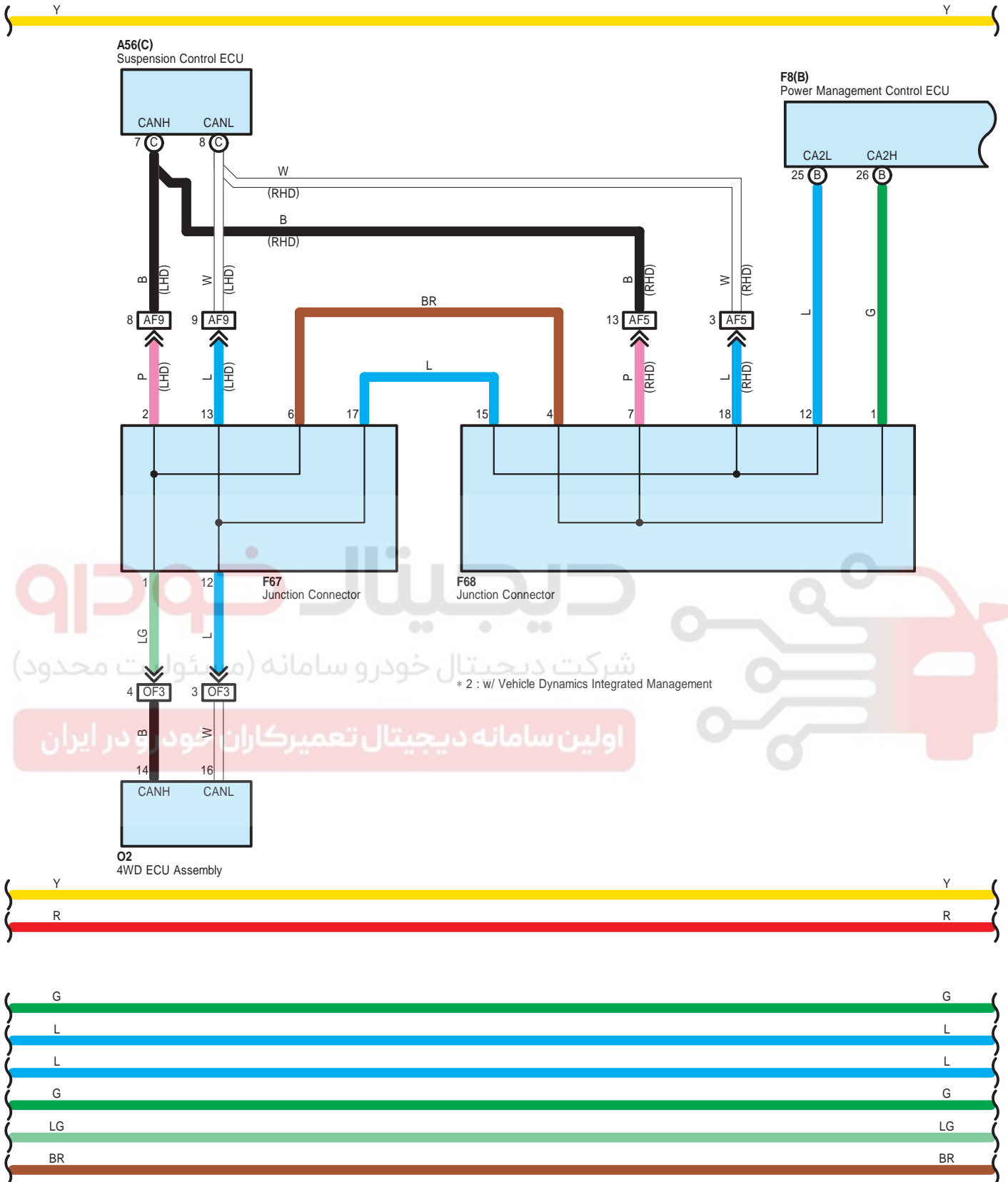

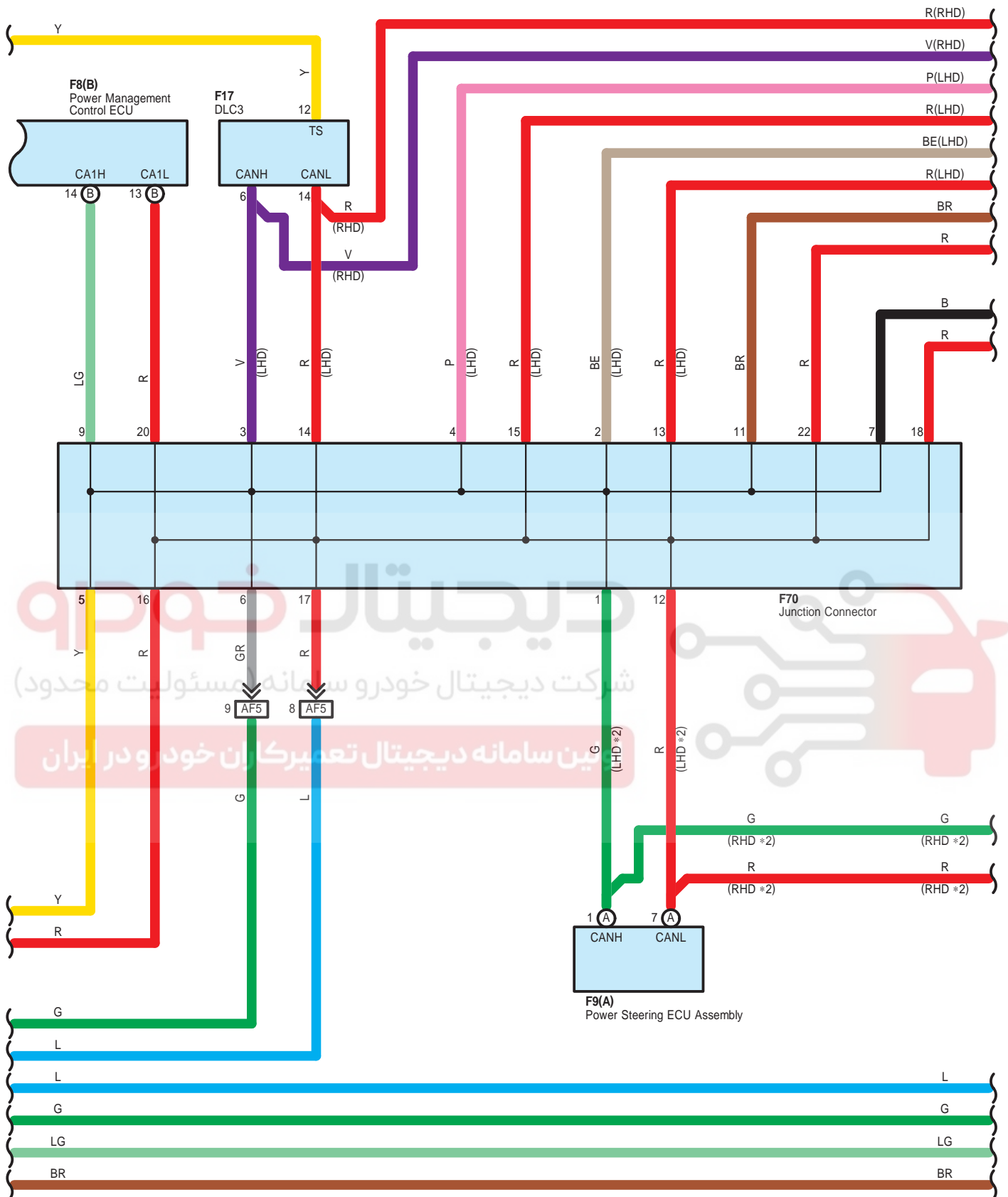



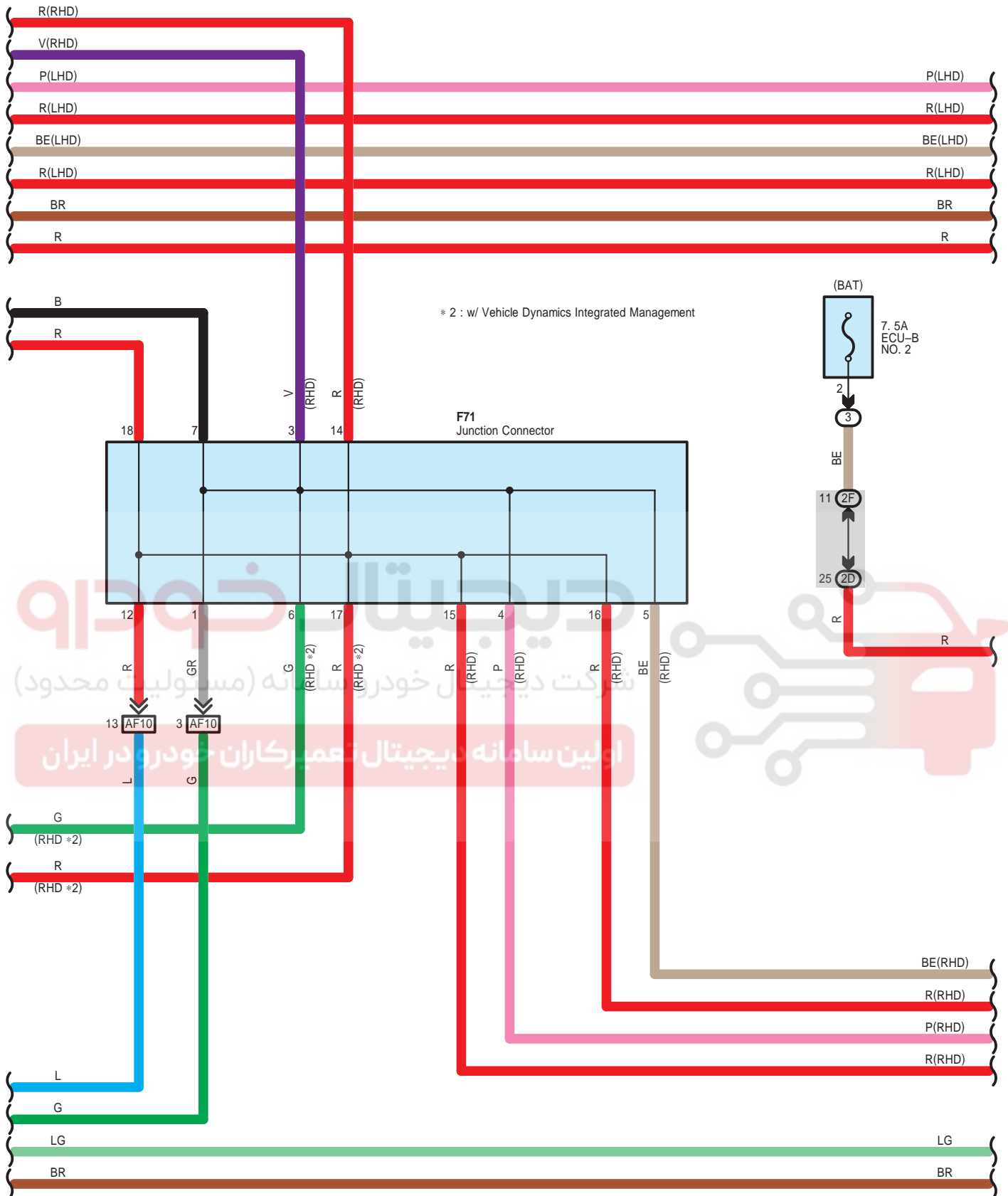

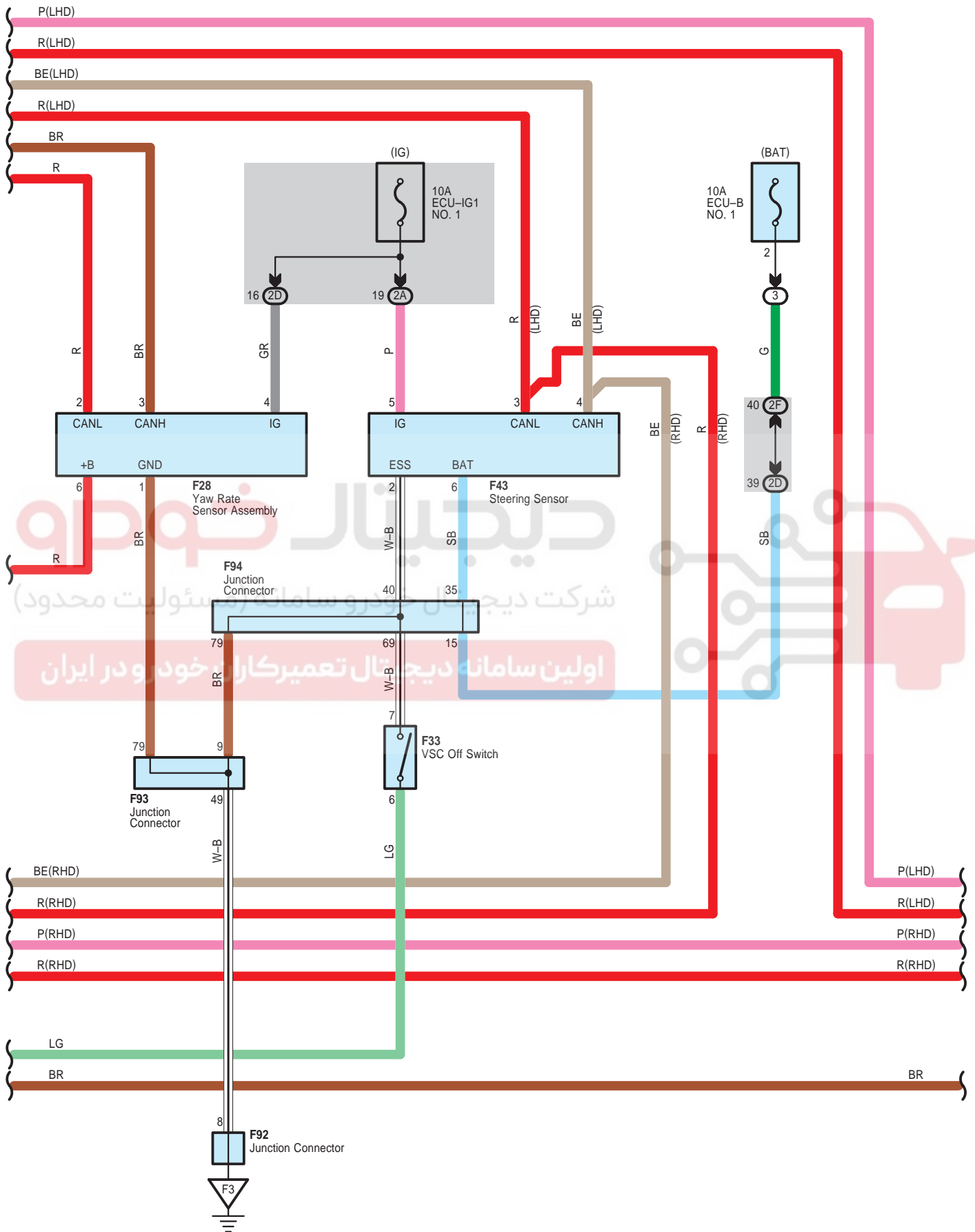

\* 6 : Before Mar. 2012 Production  
\* 7 : From Mar. 2012 Production

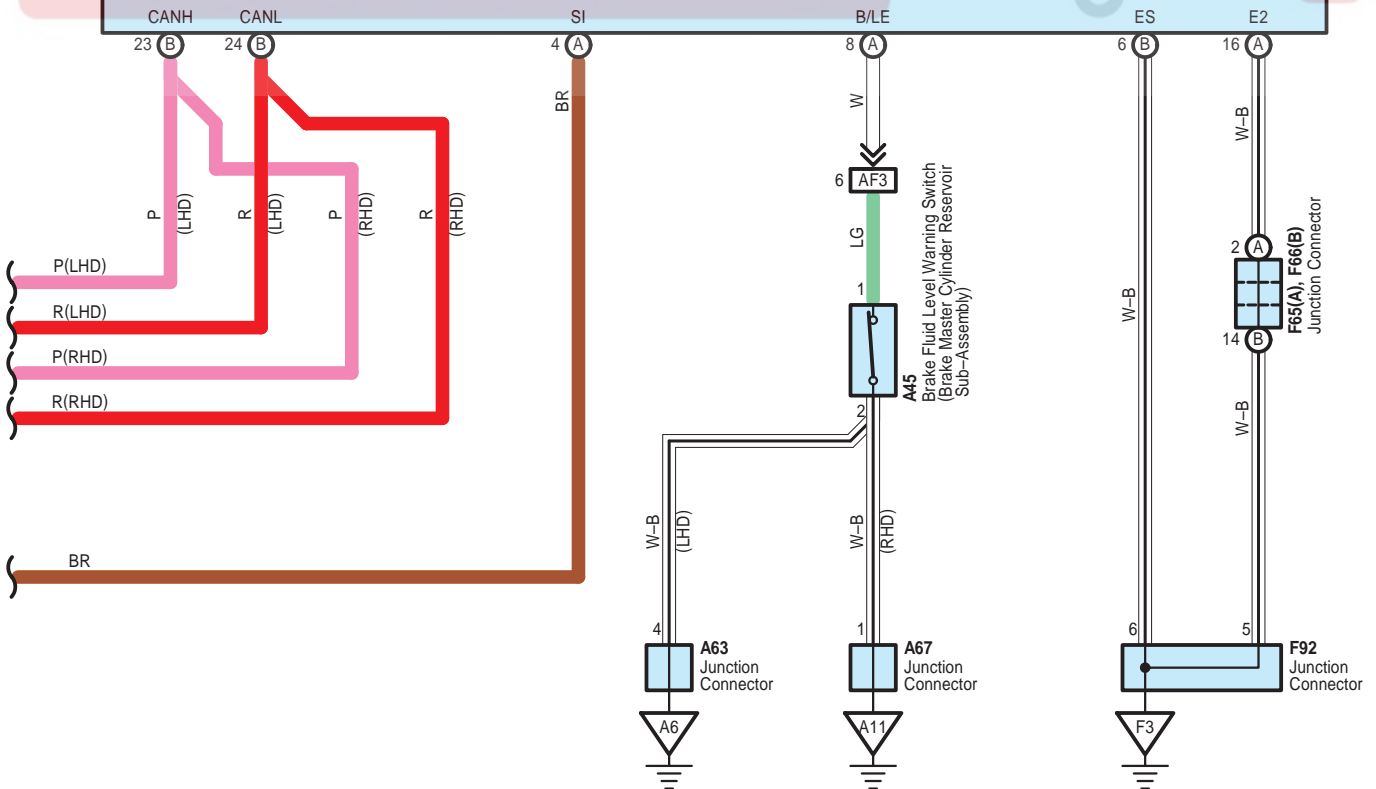
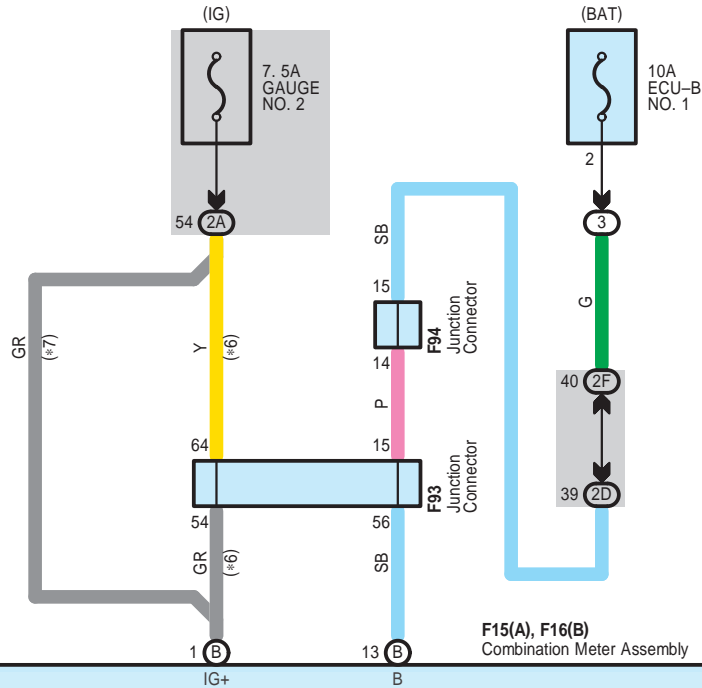

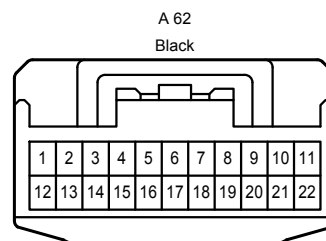
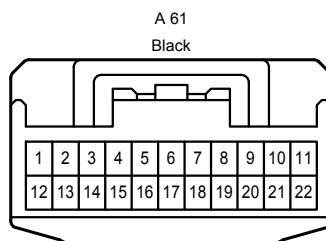
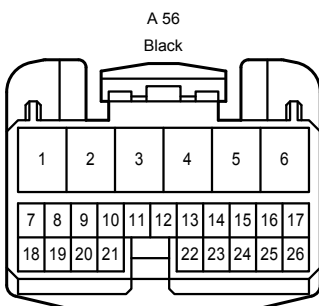
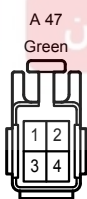
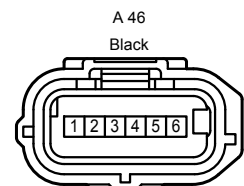
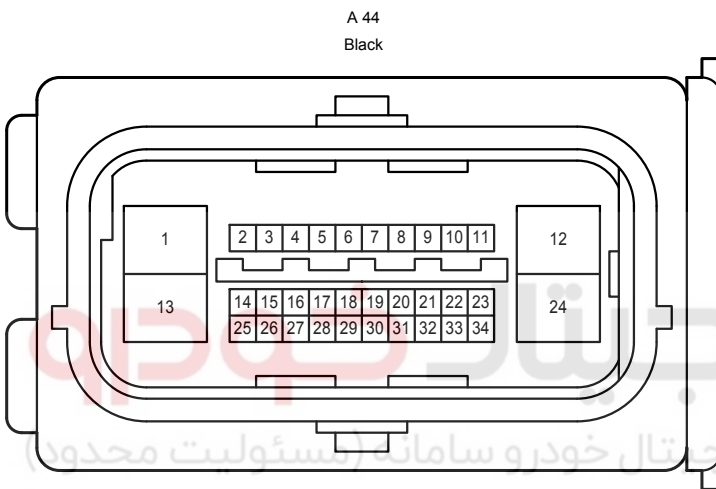
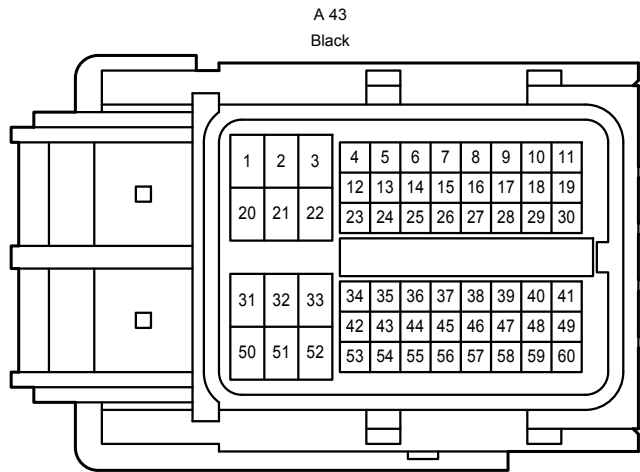
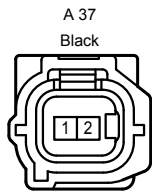
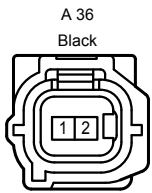

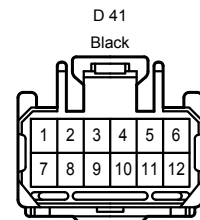
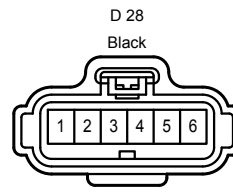
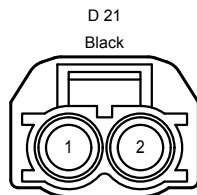
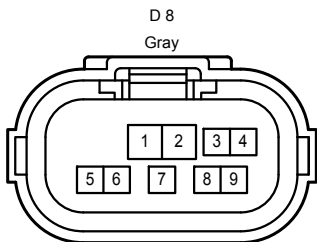
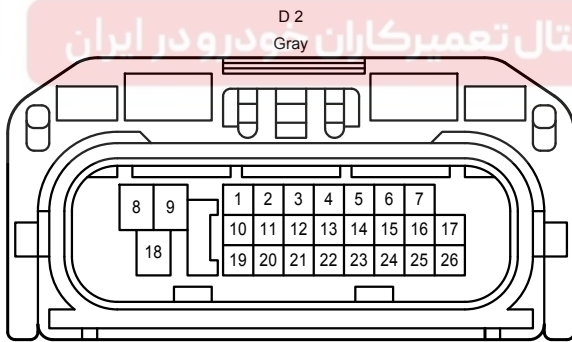
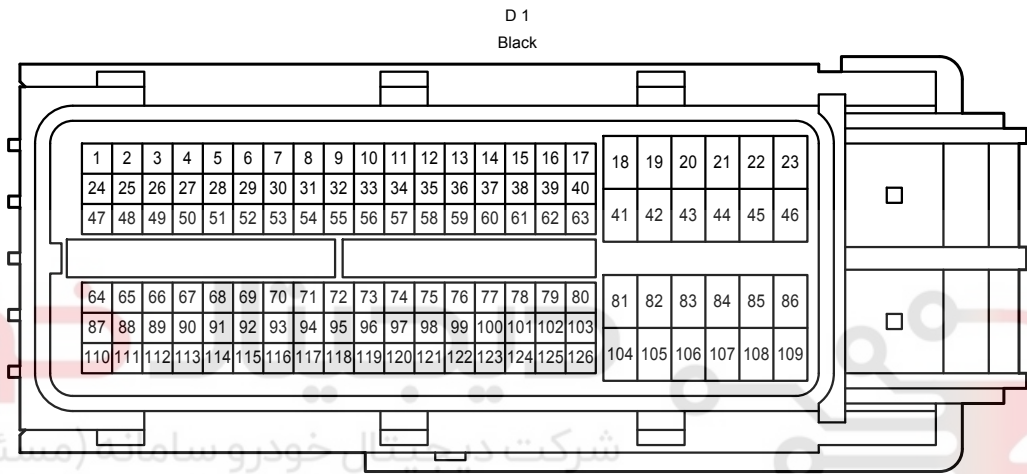
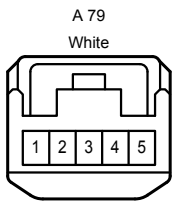
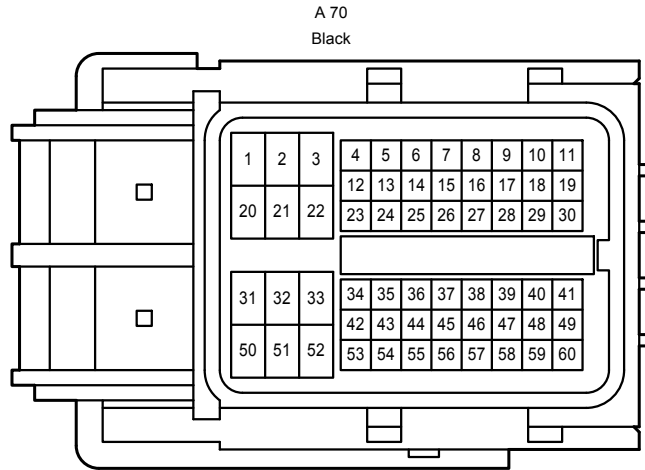
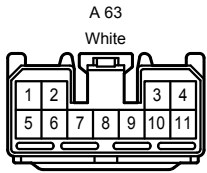

D 44  
Black

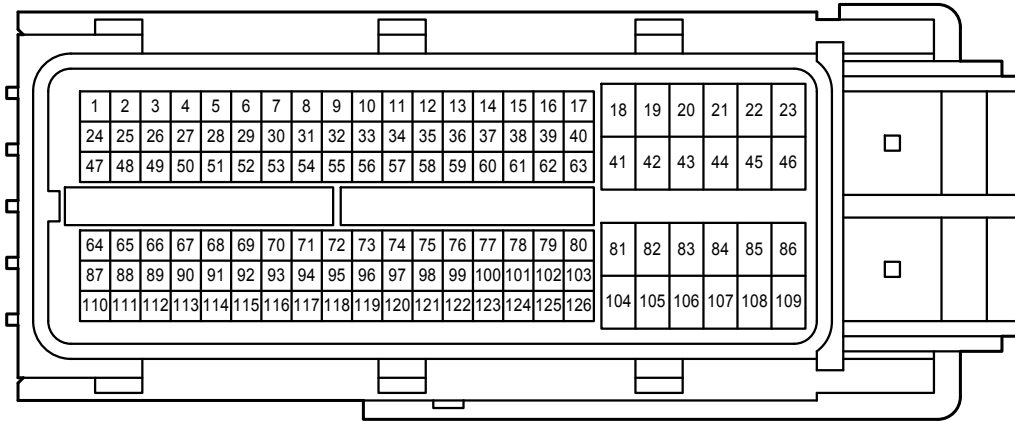

F 8  
Black

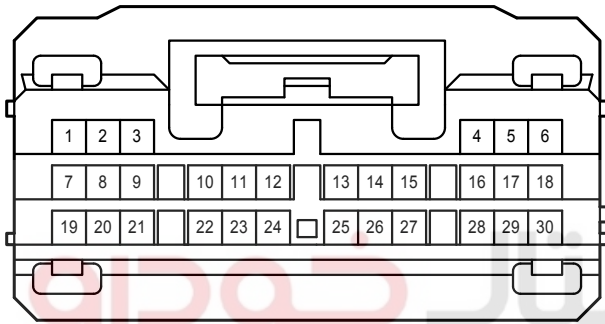

F 9  
White

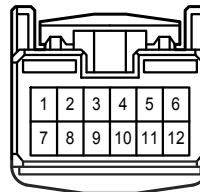

F 13  
Black

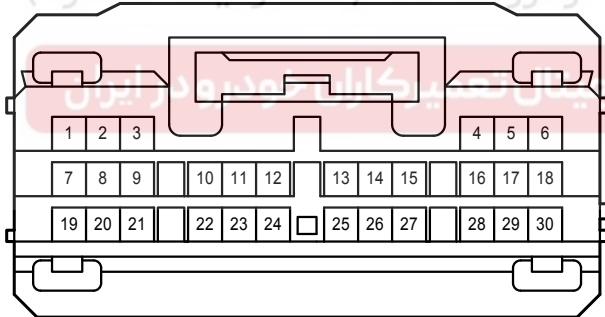

F 14  
White

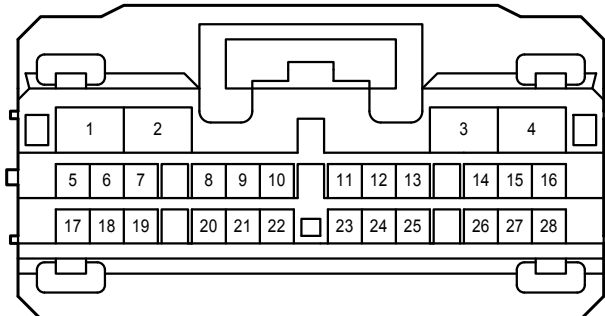

F 15  
Black

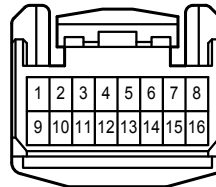

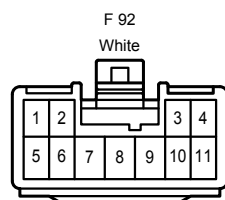
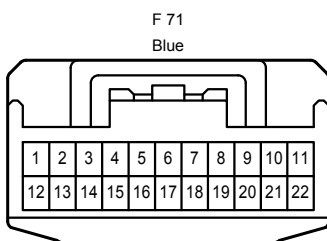
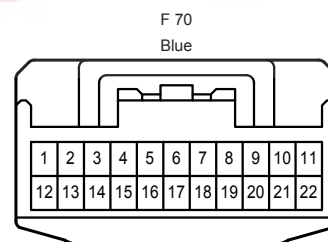
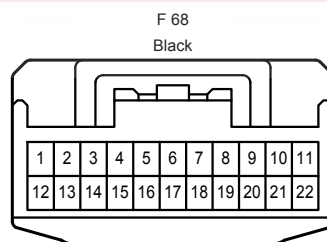
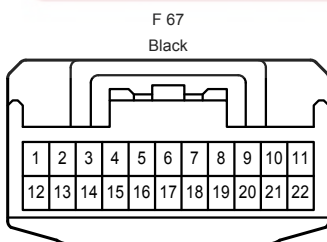
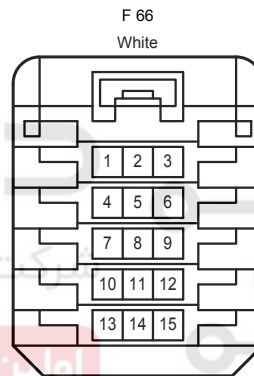
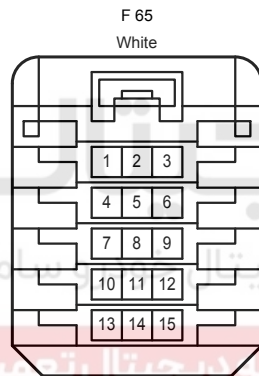
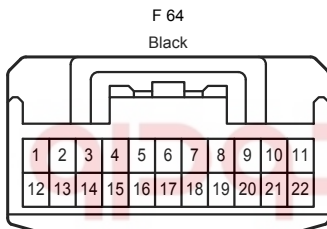
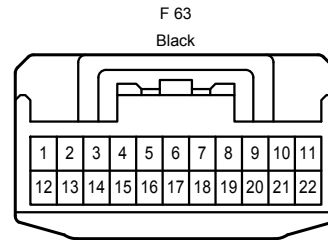
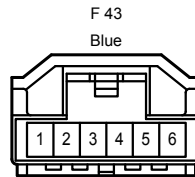
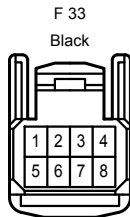
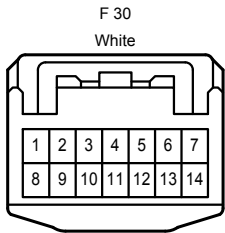
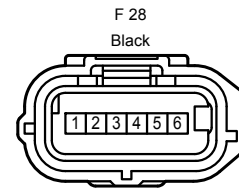
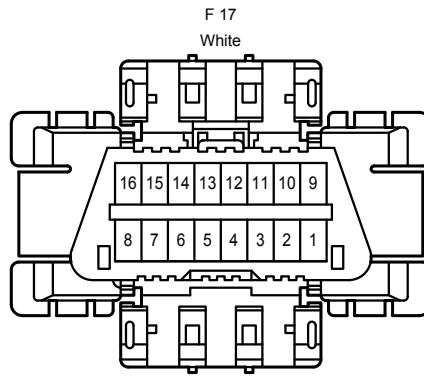
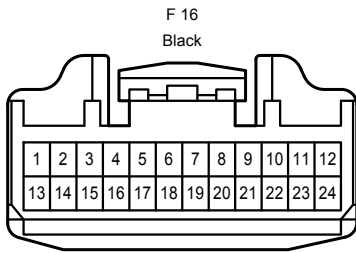

F 93  
White

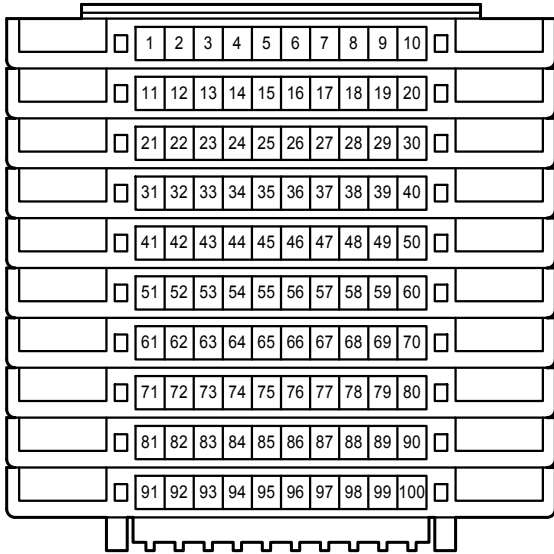

F 94  
White

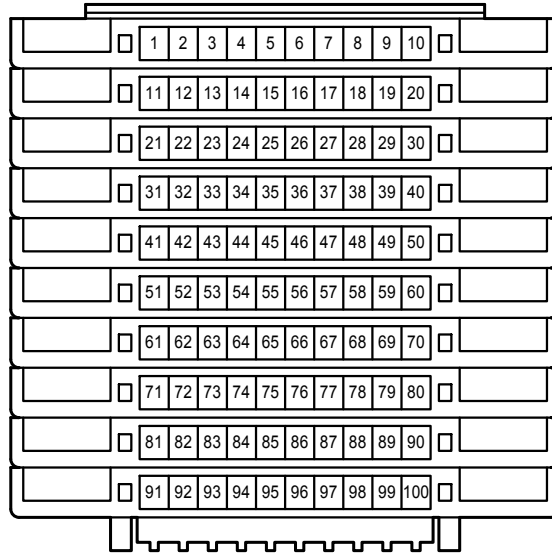

F101  
Black

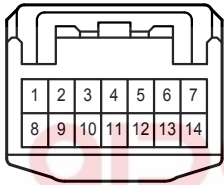

G 21  
White

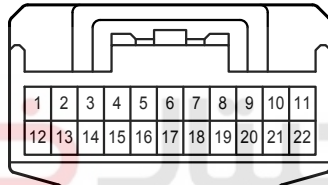

G 22  
White

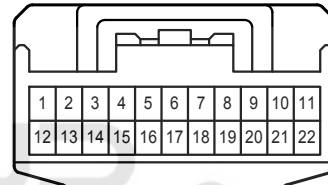

O 2  
White

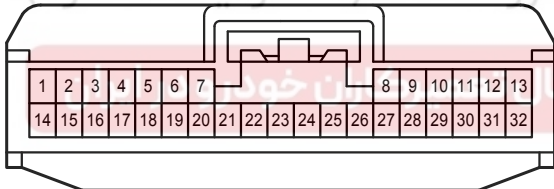

R 1  
Gray

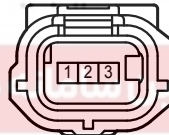

R 3  
White

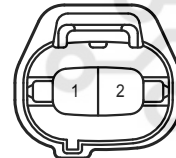

i 1  
Black

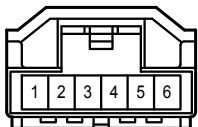

z 13  
White

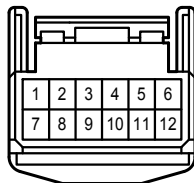

2A  
White

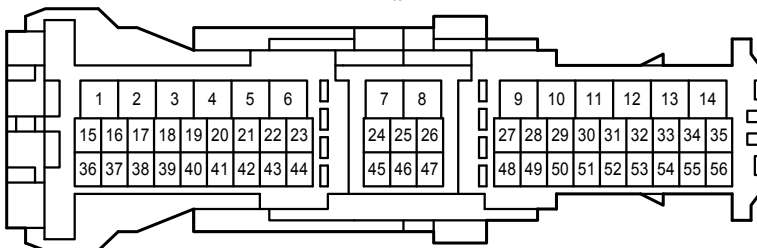



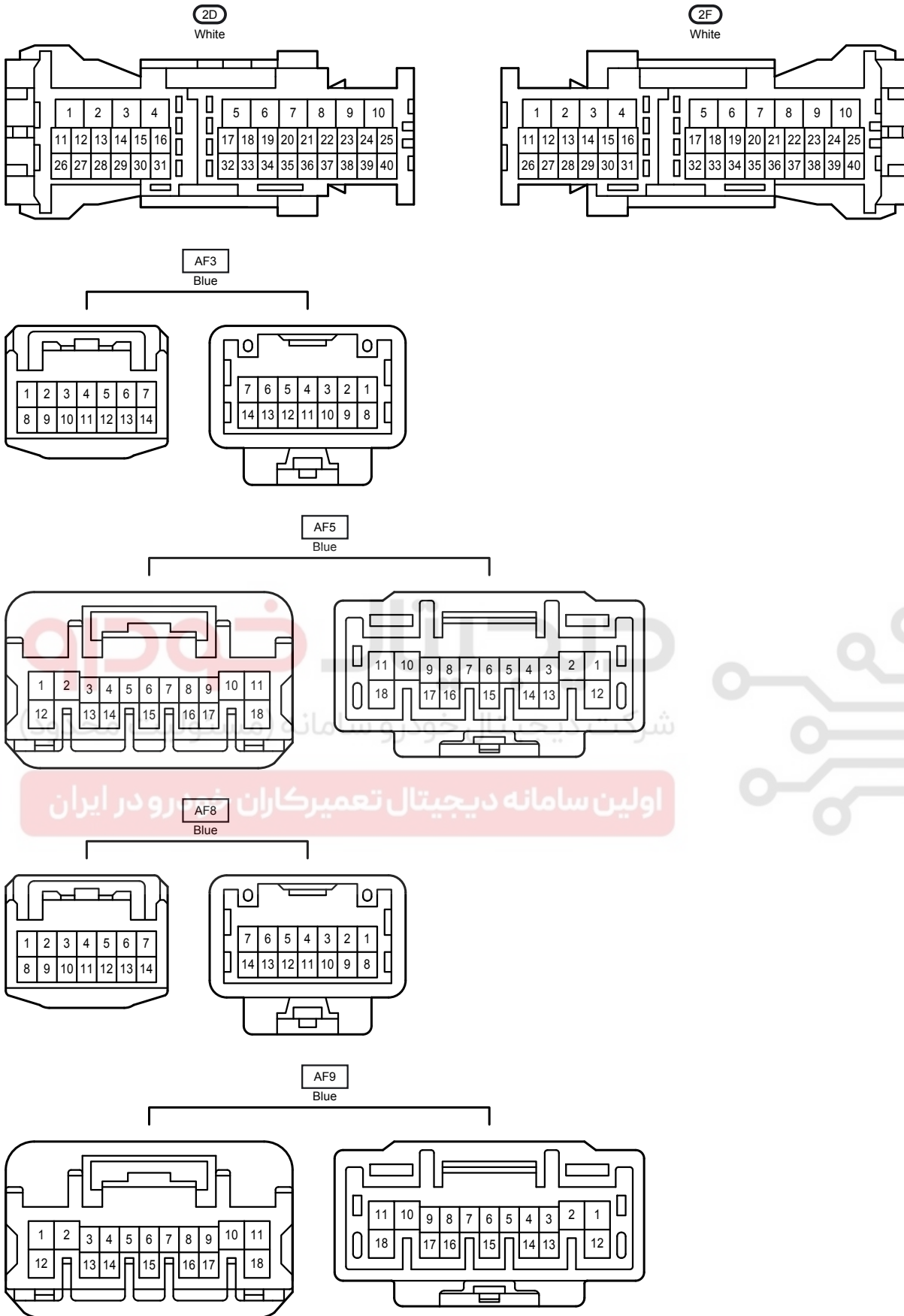

اولین سامانه دیجیتال تعمیرکاران خودرو در ایران

AF10  
Black

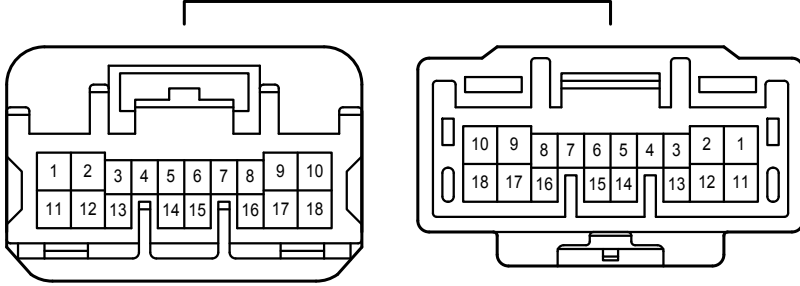

AP2  
White

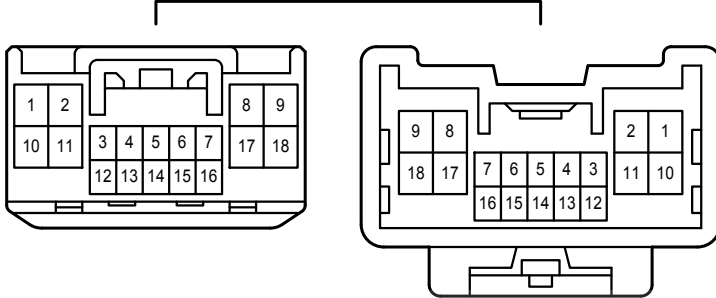

DA1  
White

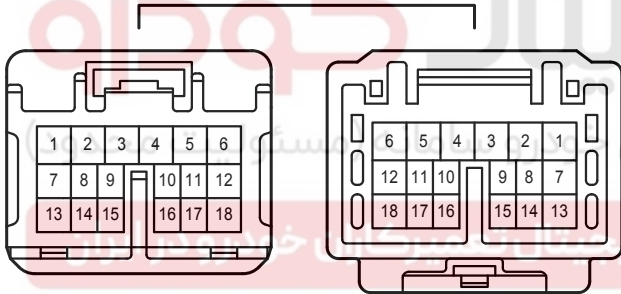

GF2  
Blue

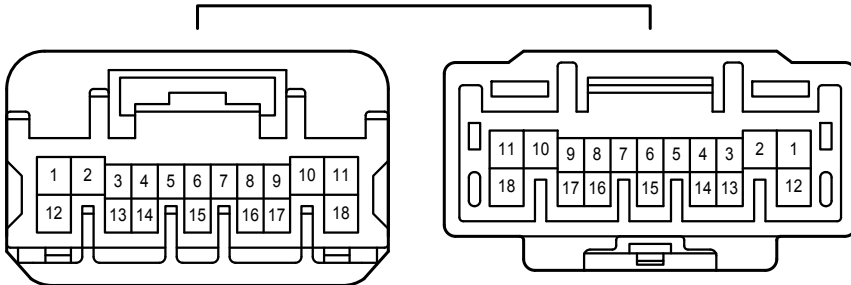

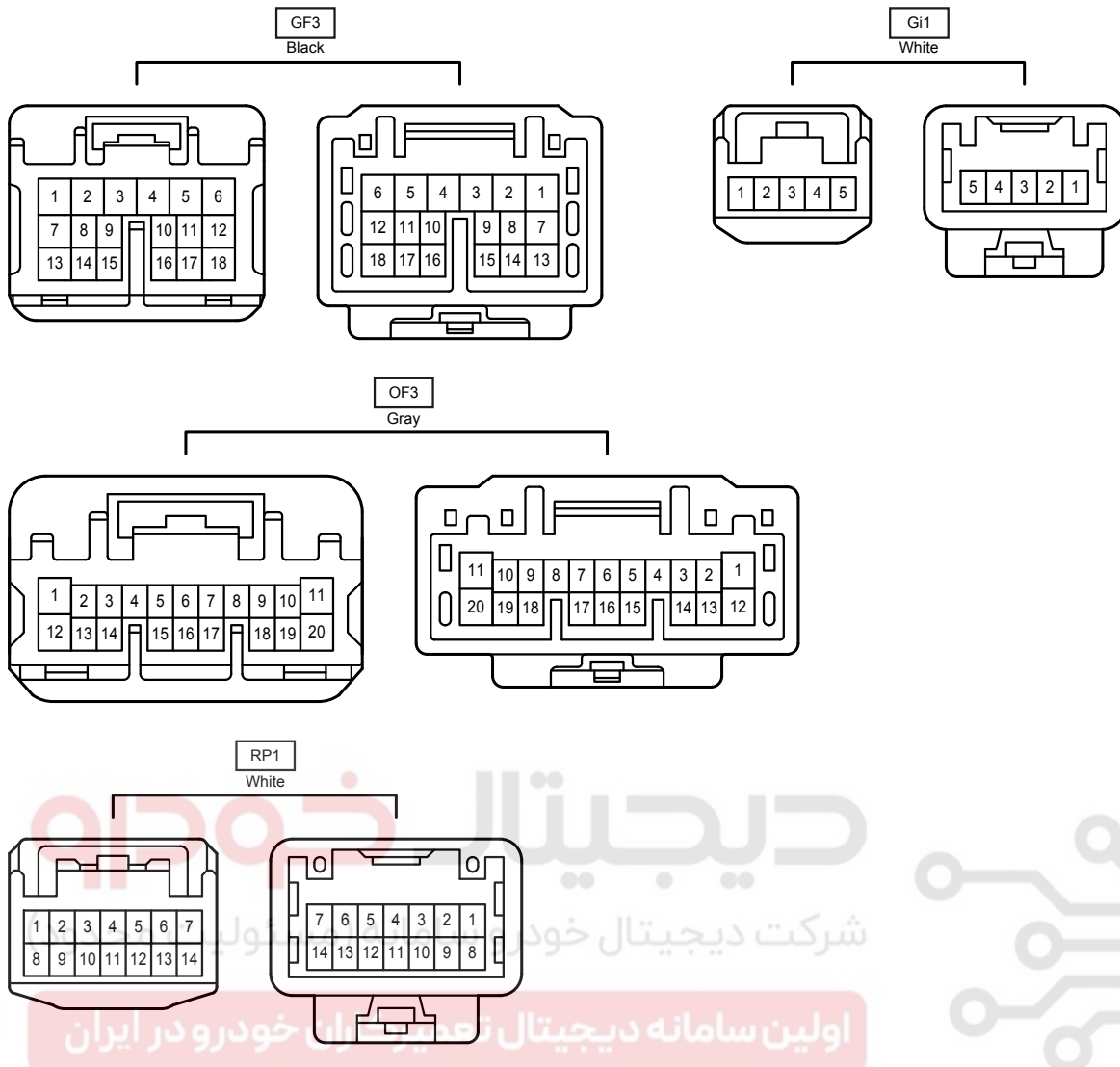

دیجیتال خودرو  
شرکت دیجیتال خودرو  
اولین سامانه دیجیتال برای خودرو در ایران