

ILLUMINATIONS E397F7B3

ILLUMINATIONS (1)

SD941-1

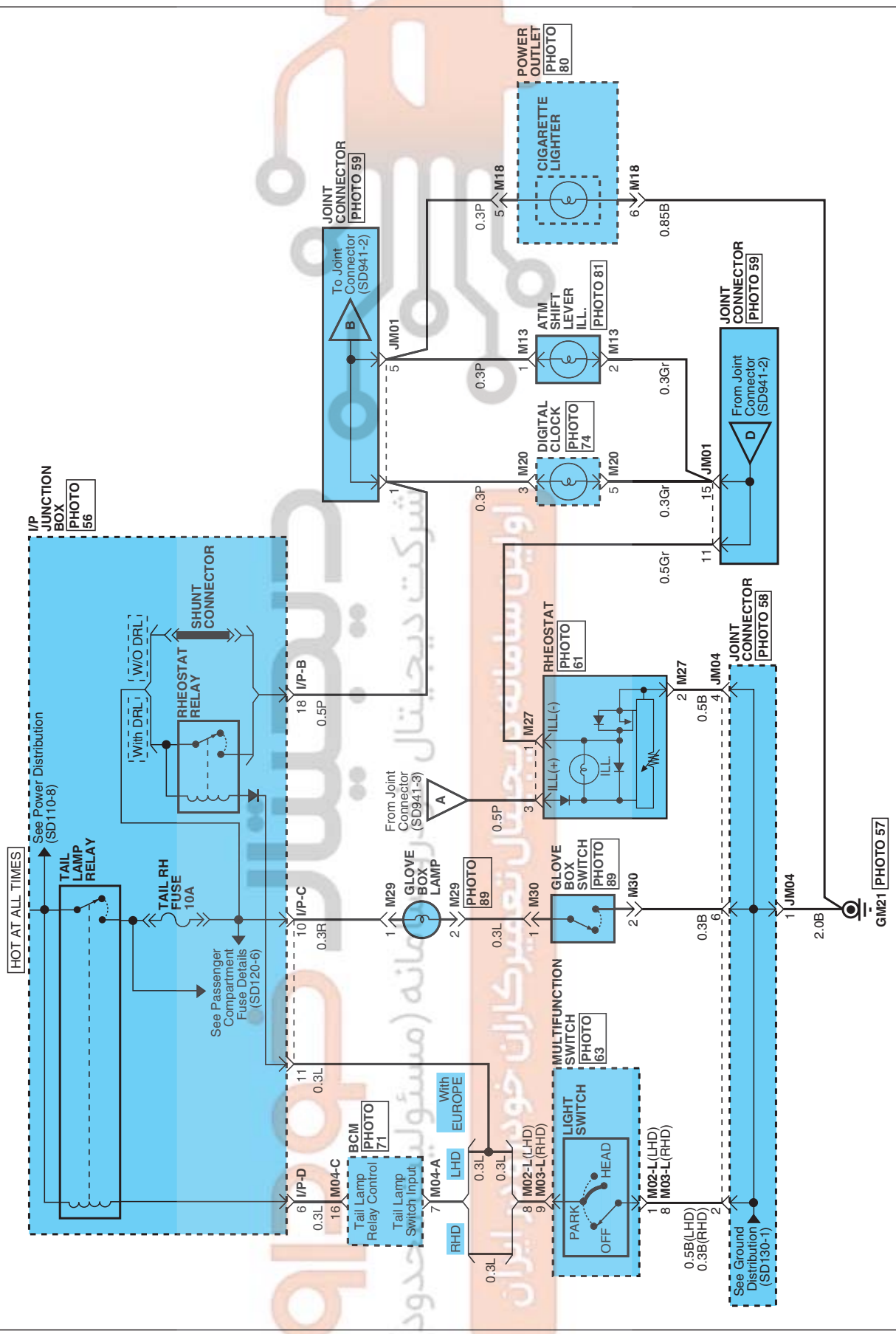

ILLUMINATIONS

ILLUMINATIONS (2)

SD941-2

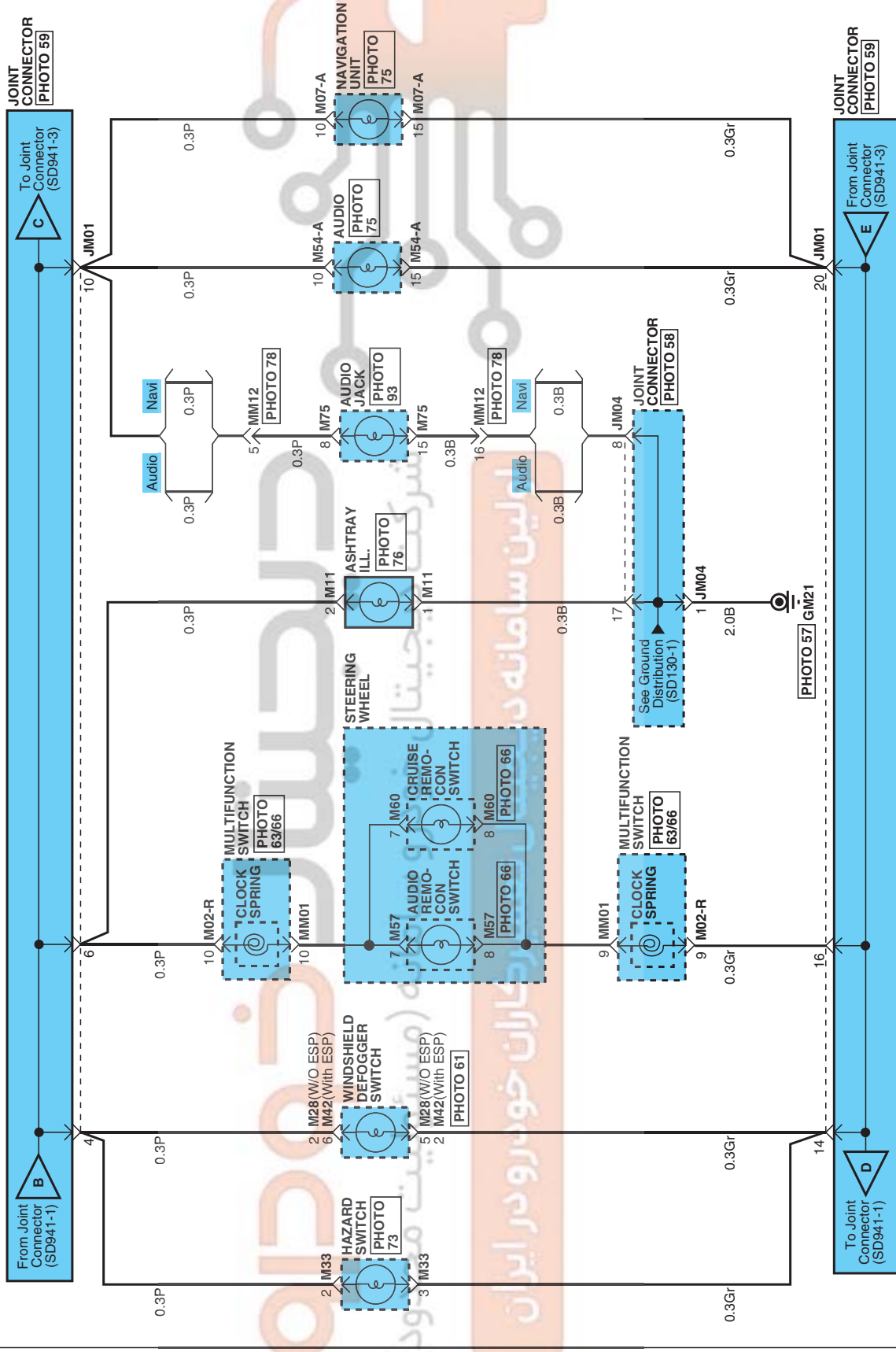

ILLUMINATIONS

ILLUMINATIONS (3)

SD941-3

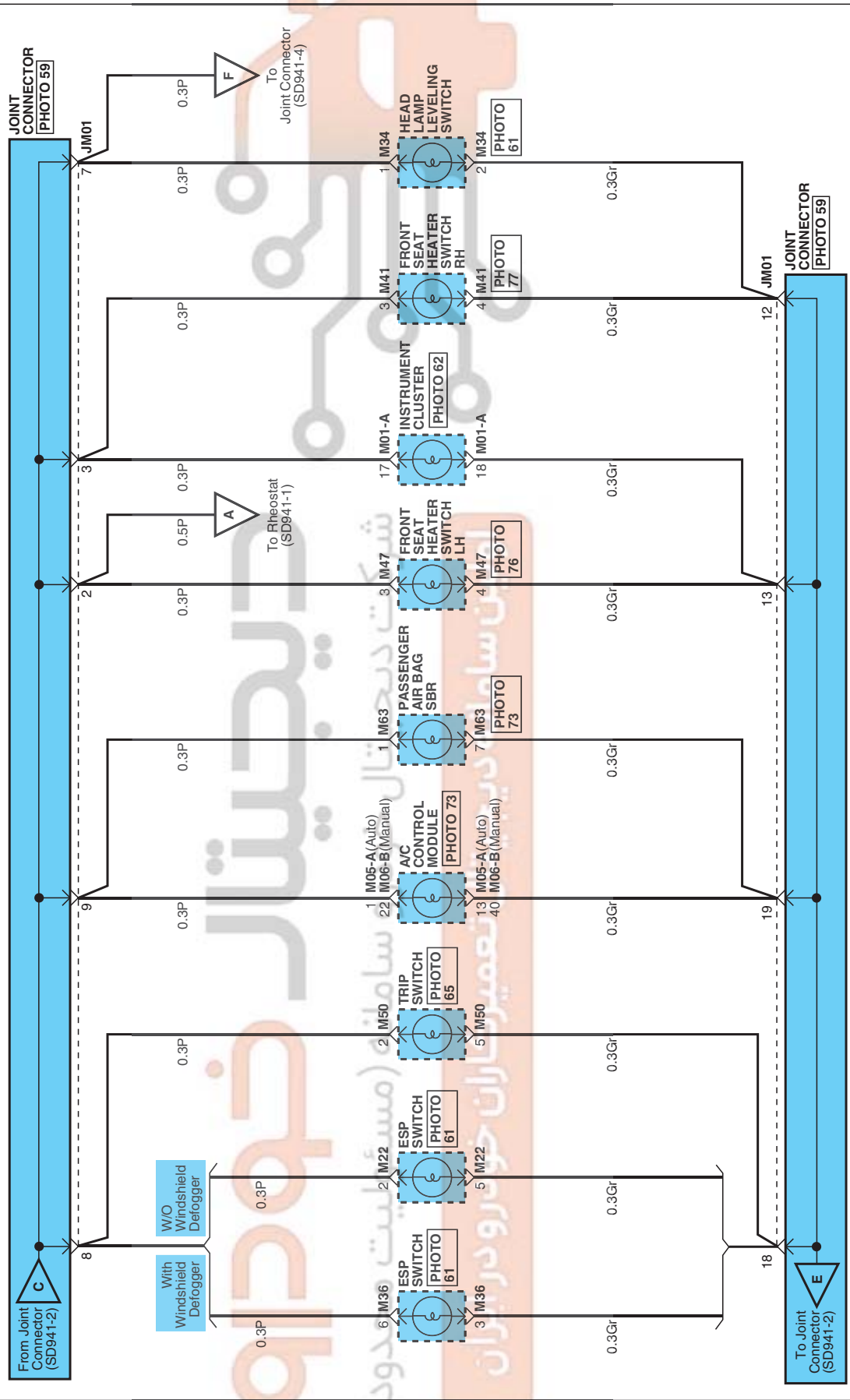

ILLUMINATIONS

ILLUMINATIONS (4)



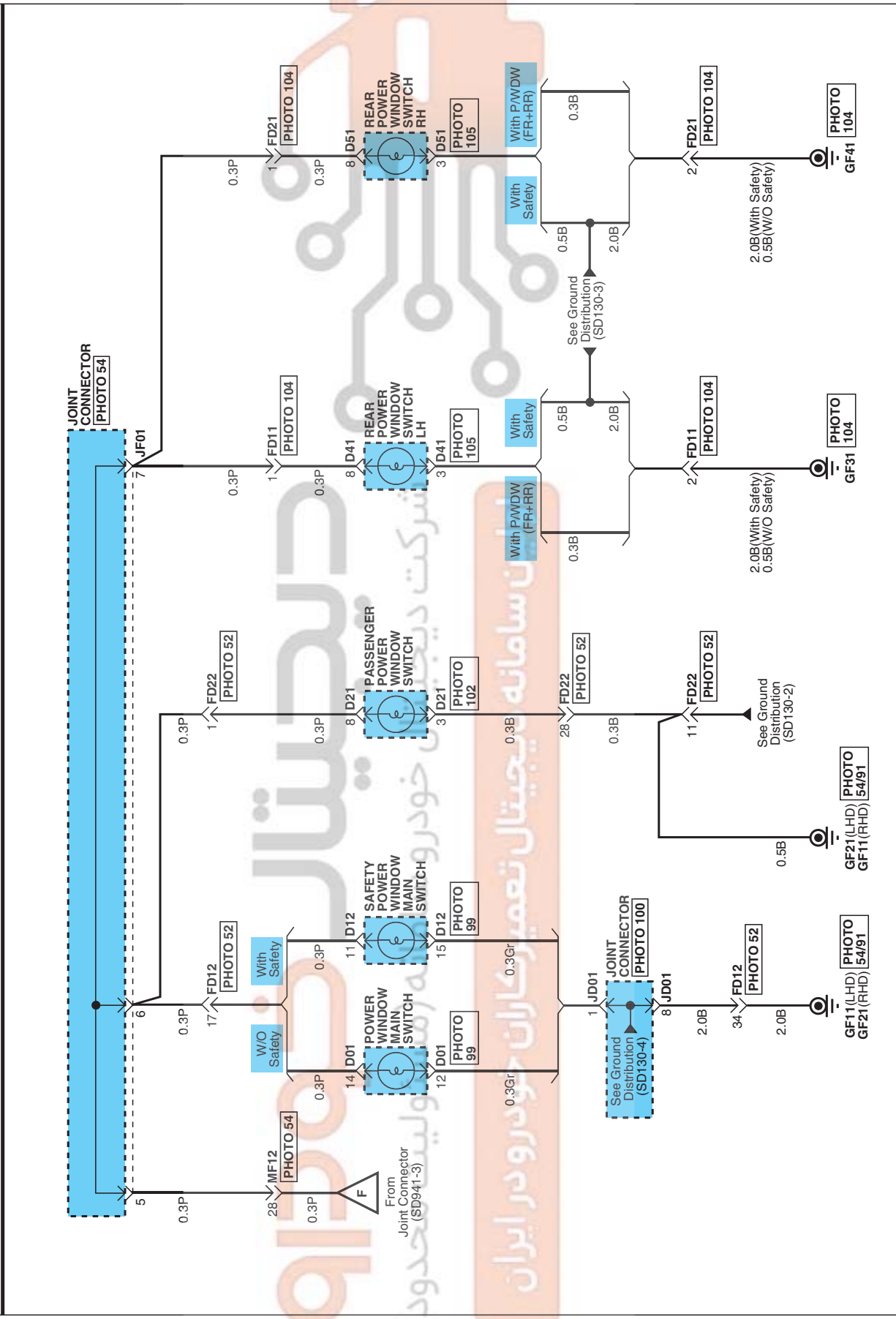

SD941-4

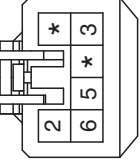
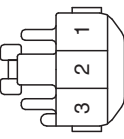
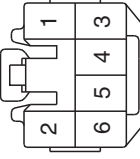
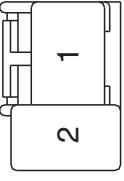

ILLUMINATIONS

ILLUMINATIONS (5)		SD941-5	
<p>D01</p> <p>KET_090IIL_16F_W</p>	<p>D12</p> <p>KET_SP_20F_W</p>	<p>D21</p> <p>KET_090IIL_08F_W</p>	<p>D41</p> <p>KET_090IIL_08F_W</p>
<p>D51</p> <p>KET_090IIL_08F_W</p>	<p>M01-A</p> <p>AMP_025_24F_W</p>	<p>M02-L</p> <p>AMP_0409_14F_W</p>	<p>M02-R</p> <p>AMP_025_12F_W</p>
<p>M03-L</p> <p>AMP_0403_14F_W</p>	<p>M04-A</p> <p>AMP_040IIL_24F_W</p>	<p>M04-C</p> <p>AMP_025_32F_W</p>	
<p>M05-A</p> <p>KET_0407_26F_W</p>	<p>M06-B</p> <p>AMP_090IIL_02F_W</p>	<p>M07-A</p> <p>CWB_CY_16F_B</p>	
<p>M11</p> <p>KET_090IIL_02F_W_L</p>	<p>M13</p> <p>AMP_090IIL_02F_W</p>	<p>M18</p> <p>KET_090IIL_06F_W</p>	<p>M20</p> <p>KET_91A_06F_W</p>

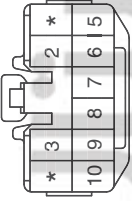
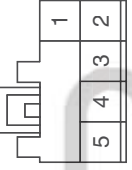
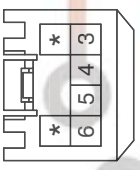
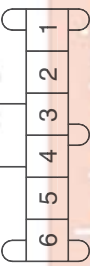
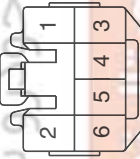
ILLUMINATIONS

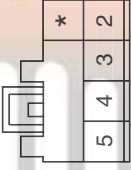
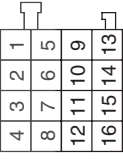
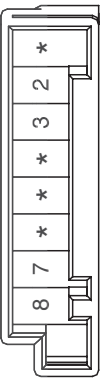
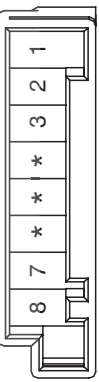
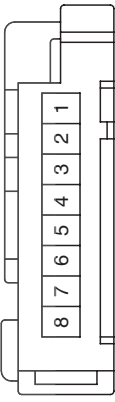
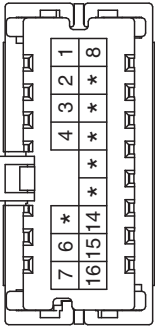
ILLUMINATIONS (6)		SD941-6		
<p>M22</p>  <p>AMP_090III_06F_Y_S2</p>	<p>M27</p>  <p>KET_090II_03F_B</p>	<p>M28</p>  <p>KET_090II_06F_L</p>	<p>M29</p>  <p>AMP_PLM2_02F_B_DL</p>	
<p>M30</p>  <p>KET_187_02F_W</p>	<p>M33</p>  <p>KET_090II_10F_W</p>	<p>M34</p>  <p>KUM_CDR_05F_W</p>	<p>M36</p>  <p>KET_090II_06F_Y_2</p>	
<p>M41</p>  <p>KET_91A_06F_W</p>	<p>M42</p>  <p>KET_090II_06F_L</p>	<p>M47</p>  <p>KET_91A_06F_W</p>	<p>M50</p>  <p>KUM_CDR_05F_B</p>	
<p>M54-A</p>  <p>CWB_CY_16F_B</p>	<p>M57</p>  <p>CR08F068</p>	<p>M60</p>  <p>CR08F068</p>	<p>M63</p>  <p>AMP_MOS_08F_W</p>	
<p>M75</p>  <p>KET_040III_16F_W</p>	<p>BLANK</p>		<p>BLANK</p>	