

ILLUMINATIONS EBC44D2B

Illuminations (1)

SD941-1

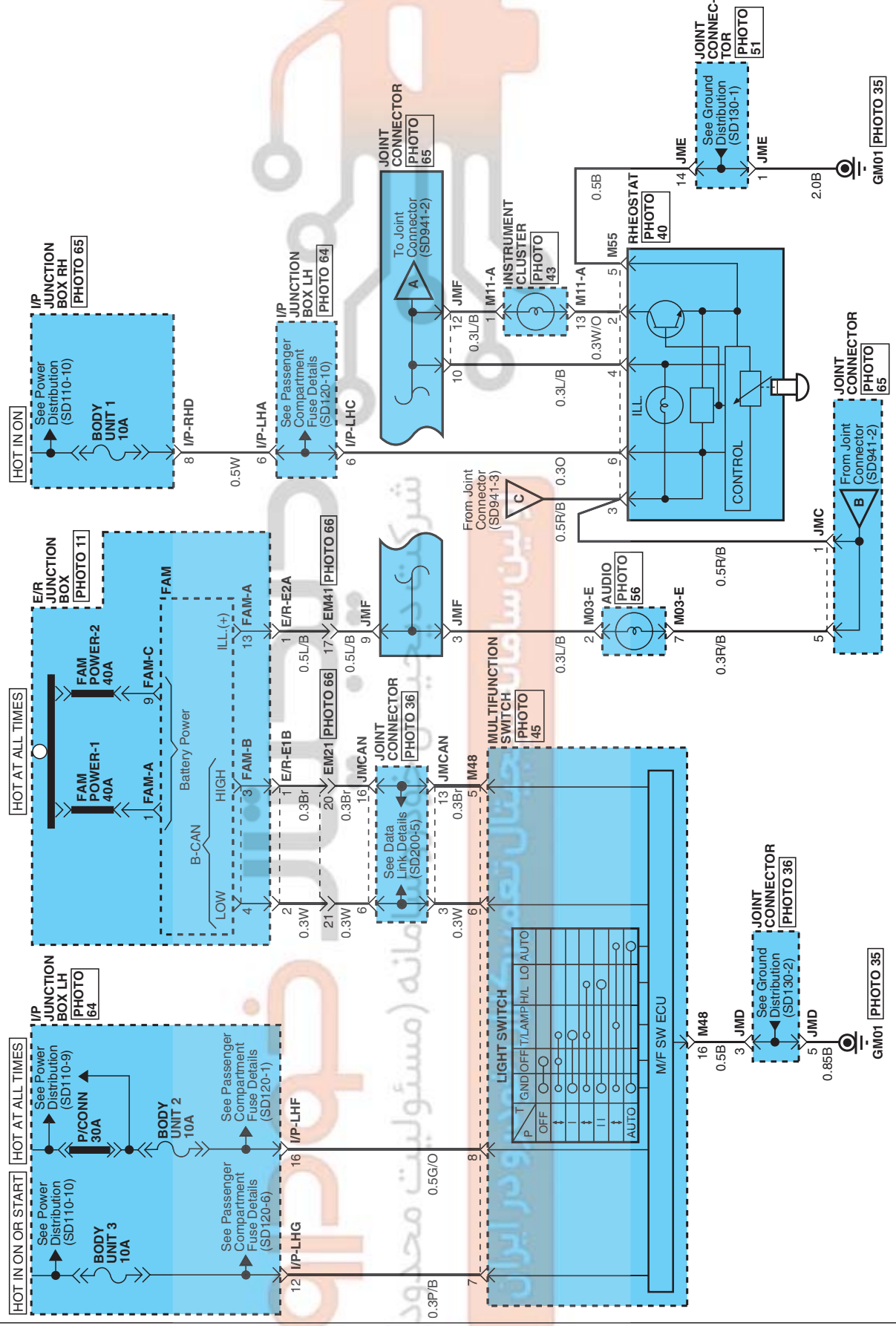

ILLUMINATIONS

Illuminations (2)

SD941-2

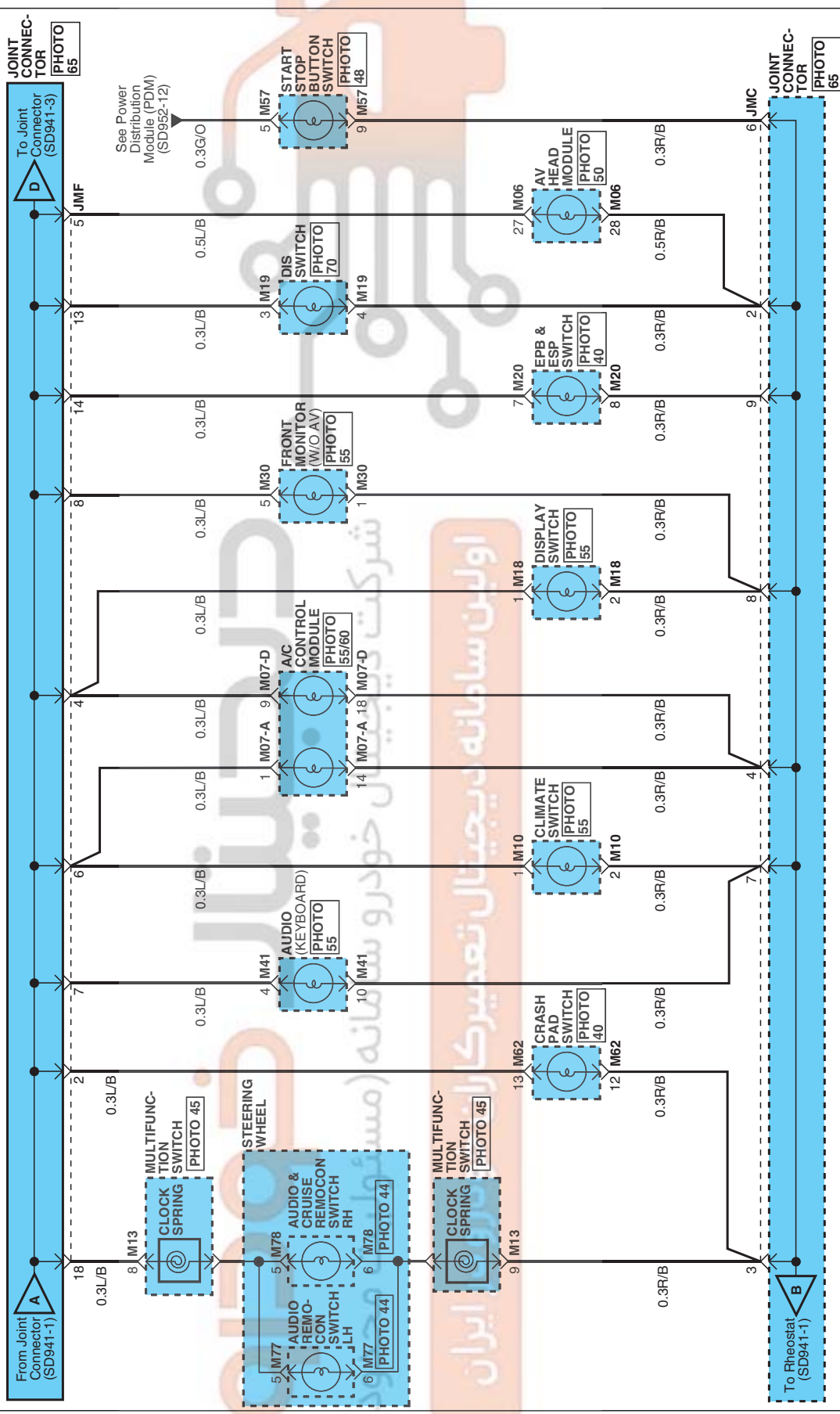

ILLUMINATIONS

Illuminations (3)

SD941-3

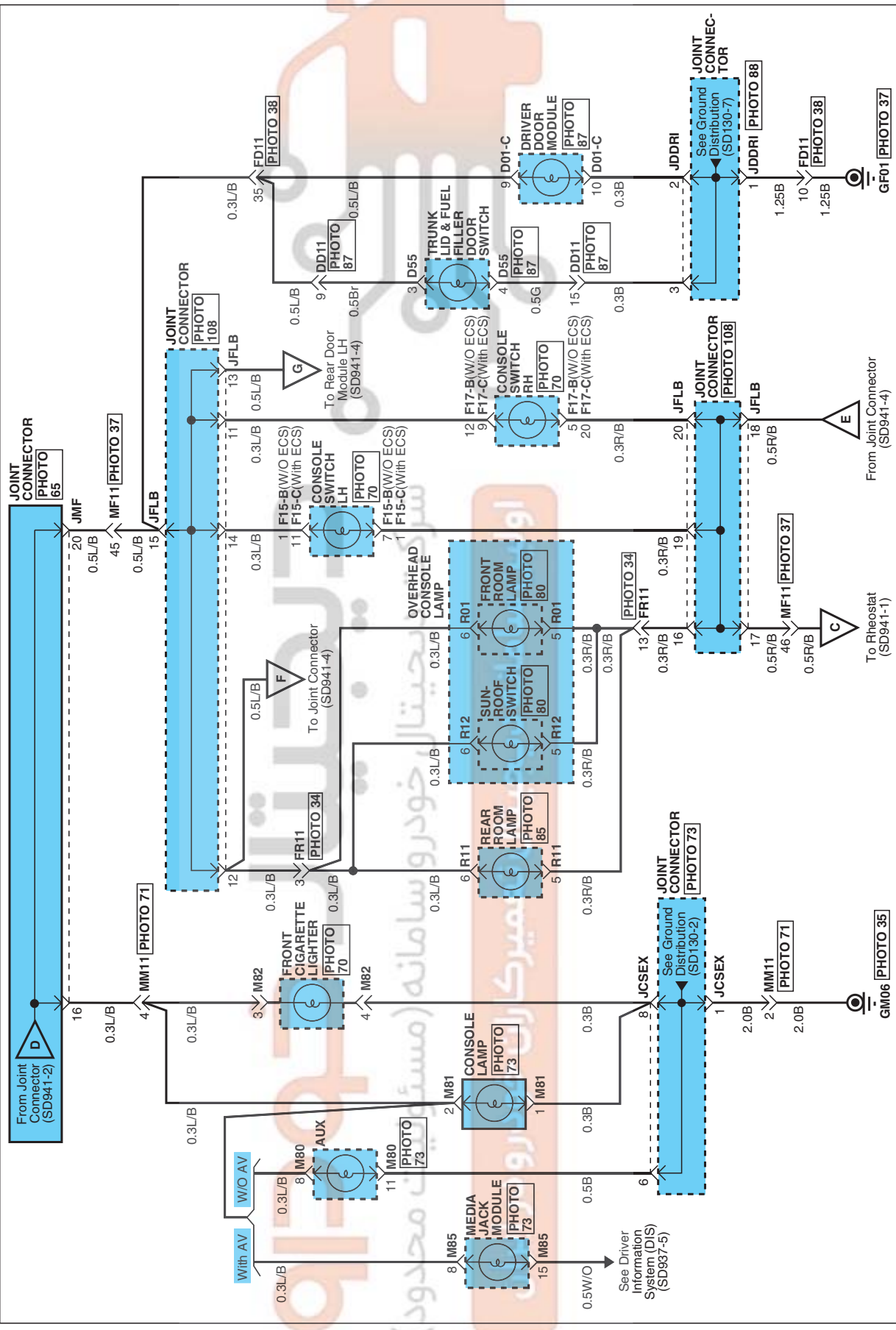

EBHSD9841CL

ILLUMINATIONS

Illuminations (4)

SD941-4

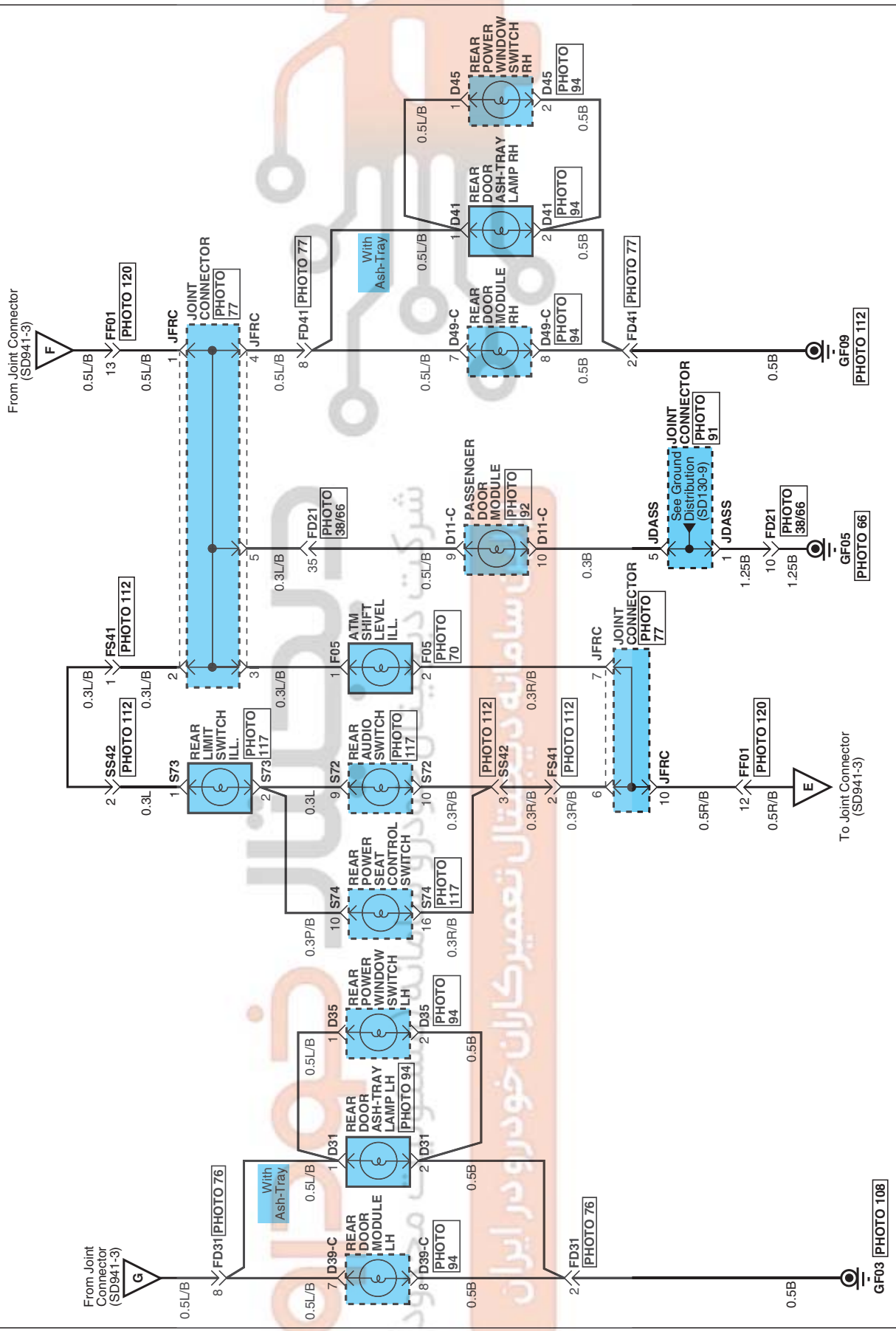

ILLUMINATIONS

SD941-5																																	
<p>D01-C</p> <p>AMP_DLI_16F_B_DL</p>	<p>D11-C</p> <p>AMP_DLI_16F_B_DL</p>	<p>D31</p> <p>KET_090I1_02F_Gr_T</p>	<p>D35</p> <p>KET_91A_06F_W</p>																														
<p>D39-C</p> <p>AMP_DLI_12F_B_DL</p>	<p>D41</p> <p>KET_090I1_02F_Gr_T</p>	<p>D45</p> <p>KET_91A_06F_W</p>	<p>D49-C</p> <p>AMP_DLI_12F_B_DL</p>																														
<p>D55</p> <p>KET_090I1_08F_W</p>	<p>FAM-A</p> <table border="1"> <tr><td>*</td><td>6</td><td>5</td><td>4</td><td>3</td><td>2</td></tr> <tr><td>13</td><td>12</td><td>11</td><td>10</td><td>9</td><td>8</td></tr> </table>	*	6	5	4	3	2	13	12	11	10	9	8	<p>FAM-B</p> <table border="1"> <tr><td>6</td><td>5</td><td>4</td><td>3</td><td>2</td><td>*</td></tr> <tr><td>*</td><td>11</td><td>*</td><td>*</td><td>8</td><td>7</td></tr> <tr><td>18</td><td>*</td><td>16</td><td>*</td><td>*</td><td>13</td></tr> </table>	6	5	4	3	2	*	*	11	*	*	8	7	18	*	16	*	*	13	<p>F15-B</p> <p>AMP_040M1_12F_B</p>
*	6	5	4	3	2																												
13	12	11	10	9	8																												
6	5	4	3	2	*																												
*	11	*	*	8	7																												
18	*	16	*	*	13																												
<p>FAM-C</p> <table border="1"> <tr><td>4</td><td>3</td><td>2</td><td>*</td></tr> <tr><td>8</td><td>7</td><td>6</td><td>5</td></tr> </table>	4	3	2	*	8	7	6	5	<p>F05</p> <p>KUM_CDR_02F_W</p>	<p>F15-C</p> <p>AMP_040M1_20F_B</p>	<p>F17-B</p> <p>AMP_070_12F_W</p>																						
4	3	2	*																														
8	7	6	5																														
<p>F17-C</p> <p>KET_040I11_20F_W</p>	<p>M03-E</p> <table border="1"> <tr><td>4</td><td>*</td><td>2</td><td>*</td></tr> <tr><td>8</td><td>7</td><td>6</td><td>*</td></tr> </table> <p>AMP_JT_08F_Gr_D2</p>	4	*	2	*	8	7	6	*	<p>BLANK</p>																							
4	*	2	*																														
8	7	6	*																														

ILLUMINATIONS

illuminations (6)

SD941-6	
M06	M07-D
<p>Diagram of M06 illuminations showing a large rectangular panel with multiple rows of pins and labels.</p>	<p>Diagram of M07-D illuminations showing a 2x10 grid of pins labeled 1-10 and 11-20.</p>
M13	M11-A
<p>Diagram of M13 illuminations showing a 2x5 grid of pins labeled 1-5 and 6-10.</p>	<p>Diagram of M11-A illuminations showing a 2x5 grid of pins labeled 1-5 and 6-10.</p>
M18	M20
<p>Diagram of M18 illuminations showing a 2x3 grid of pins labeled 1-3 and 4-6.</p>	<p>Diagram of M20 illuminations showing a 2x5 grid of pins labeled 1-5 and 6-10.</p>
M30	M55
<p>Diagram of M30 illuminations showing a 2x5 grid of pins labeled 1-5 and 6-10.</p>	<p>Diagram of M55 illuminations showing a 2x5 grid of pins labeled 1-5 and 6-10.</p>
M41	M78
<p>Diagram of M41 illuminations showing a 2x5 grid of pins labeled 1-5 and 6-10.</p>	<p>Diagram of M78 illuminations showing a 2x5 grid of pins labeled 1-5 and 6-10.</p>
M48	M77
<p>Diagram of M48 illuminations showing a 2x5 grid of pins labeled 1-5 and 6-10.</p>	<p>Diagram of M77 illuminations showing a 2x5 grid of pins labeled 1-5 and 6-10.</p>
M57	M78
<p>Diagram of M57 illuminations showing a 2x5 grid of pins labeled 1-5 and 6-10.</p>	<p>Diagram of M78 illuminations showing a 2x5 grid of pins labeled 1-5 and 6-10.</p>

ILLUMINATIONS

Illuminations (7)

SD941-7

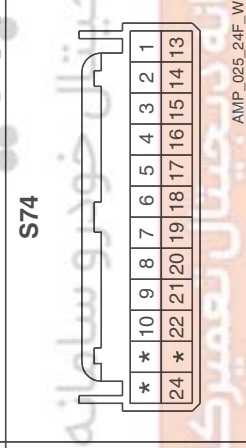
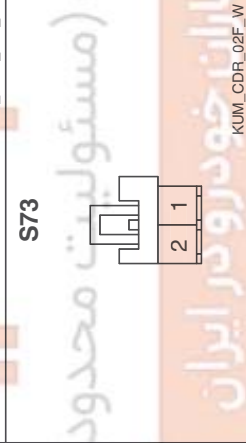
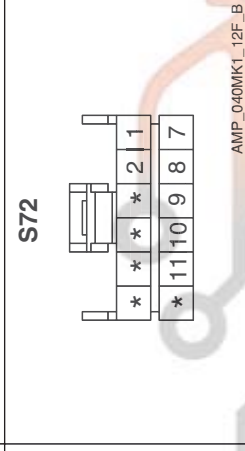
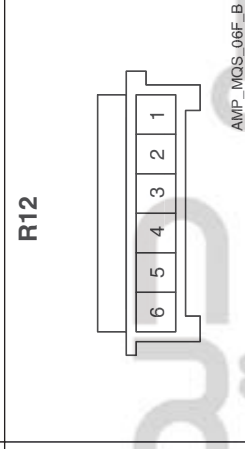
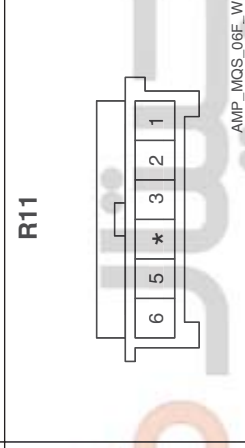
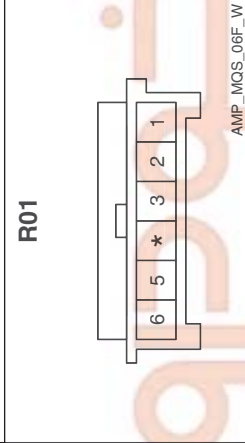
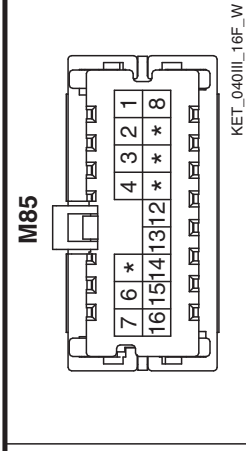
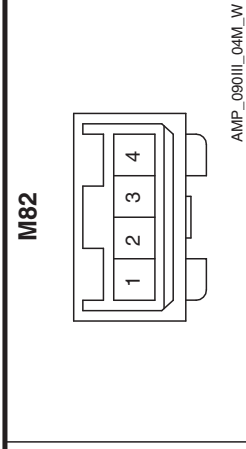
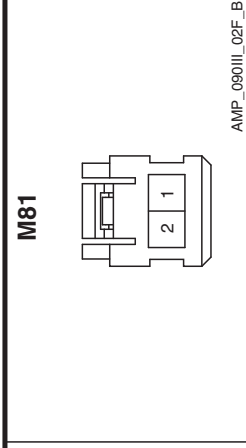
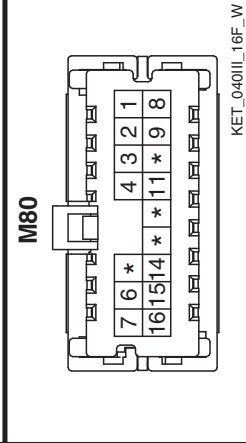

ILLUMINATIONS

Illuminations (8)

MEMO

SD941-8

دیجیتال خودرو

شرکت دیجیتال خودرو سامانه (مسئولیت محدود)

اولین سامانه دیجیتال تعمیرکاران خودرو در ایران

